

 <p>S.C. "DROMCONS" S.R.L. SEBIS, str. Codrului nr. 1 C.U.I 15624428 J02/912/2003 tel : +40(0)743 119 667, tel / fax: +40(0)357 437 554 e-mail : office@dromcons.ro</p>		BENEFICIAR:	COMUNA VLADIMIRESCU	PROIECT NR.	
	DENUMIRE PROIECT:	Amenajare străzi zonă locuințe, Vladimirescu zonă nouă, județul Arad	62/2013		
SEF PROIECT:	dpl. ing. ADRIAN PRAHOVEANU 	OBIECT:	DRUMURI	SCARA:	D.T.+C.S.
PROIECTAT	Dpl. Ing. FLORE CRISTIAN 	%	PLAN DE AMPLASARE IN ZONA	PLANSĂ NR.	01D-01
DESENAT:	Dpl. Ing. FLORE CRISTIAN	2013			



 S.C. "DROMCONS" S.R.L. SEBIS, str. Codrului nr. 1 C.U.I 15624428 J02/912/2003 tel : +40(0)743 119 667, tel / fax: +40(0)357 437 554 e-mail : office@dromcons.ro		BENEFICIAR: COMUNA VLADIMIRESCU DENUMIRE PROIECT: Amenajare străzi zonă locuințe, Vladimirescu zonă nouă, județul Arad OBIECT: DRUMURI	PROIECT NR. 62/2013
	SEF PROIECT: dpl. Ing. ADRIAN PRAHOVEANU PROIECTAT Dpl. Ing. FLORE CRISTIAN DESENAT: Dpl. Ing. FLORE CRISTIAN	SCARA: 1:5000 2013	PLAN DE ANSAMBLU

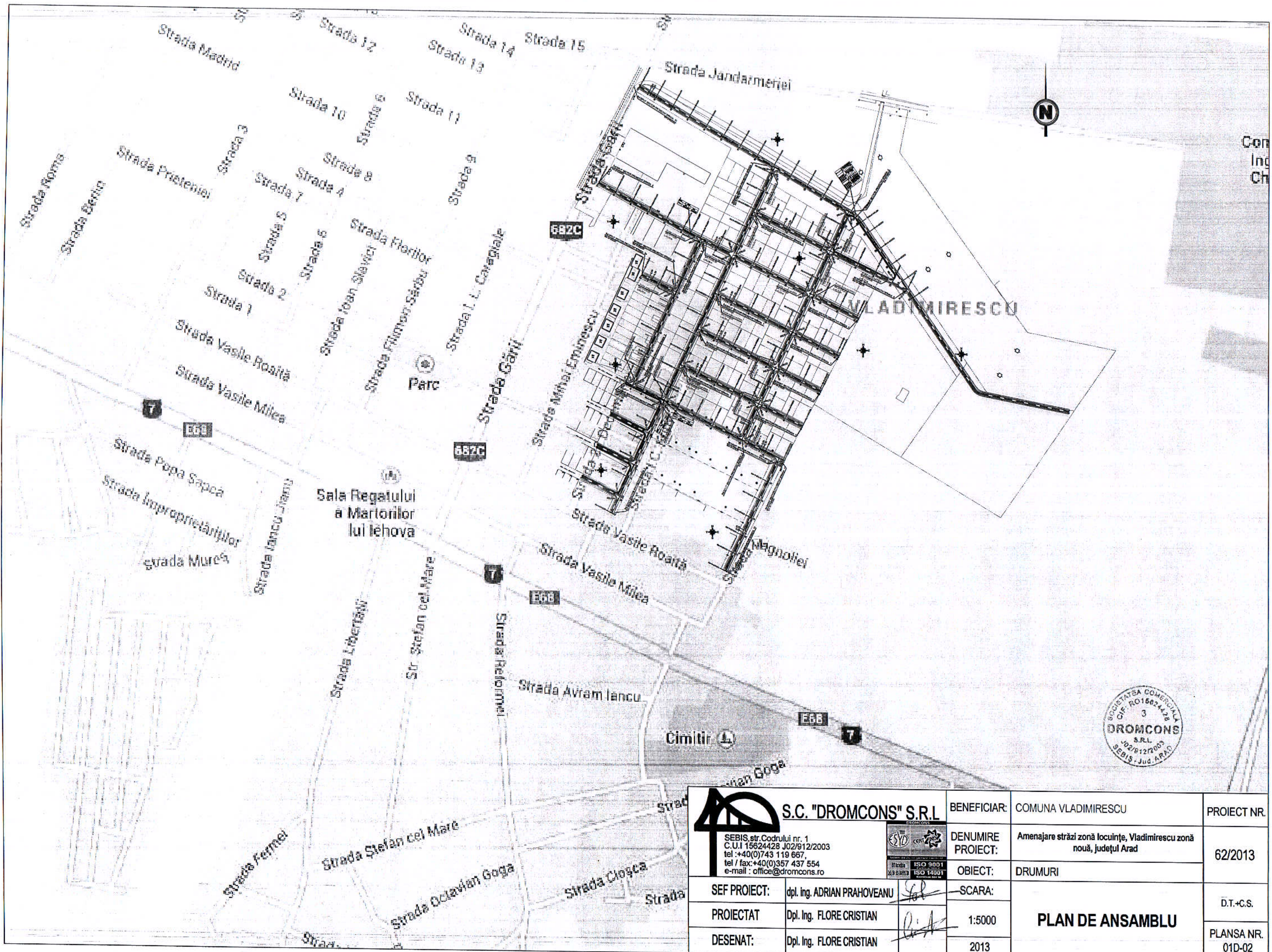
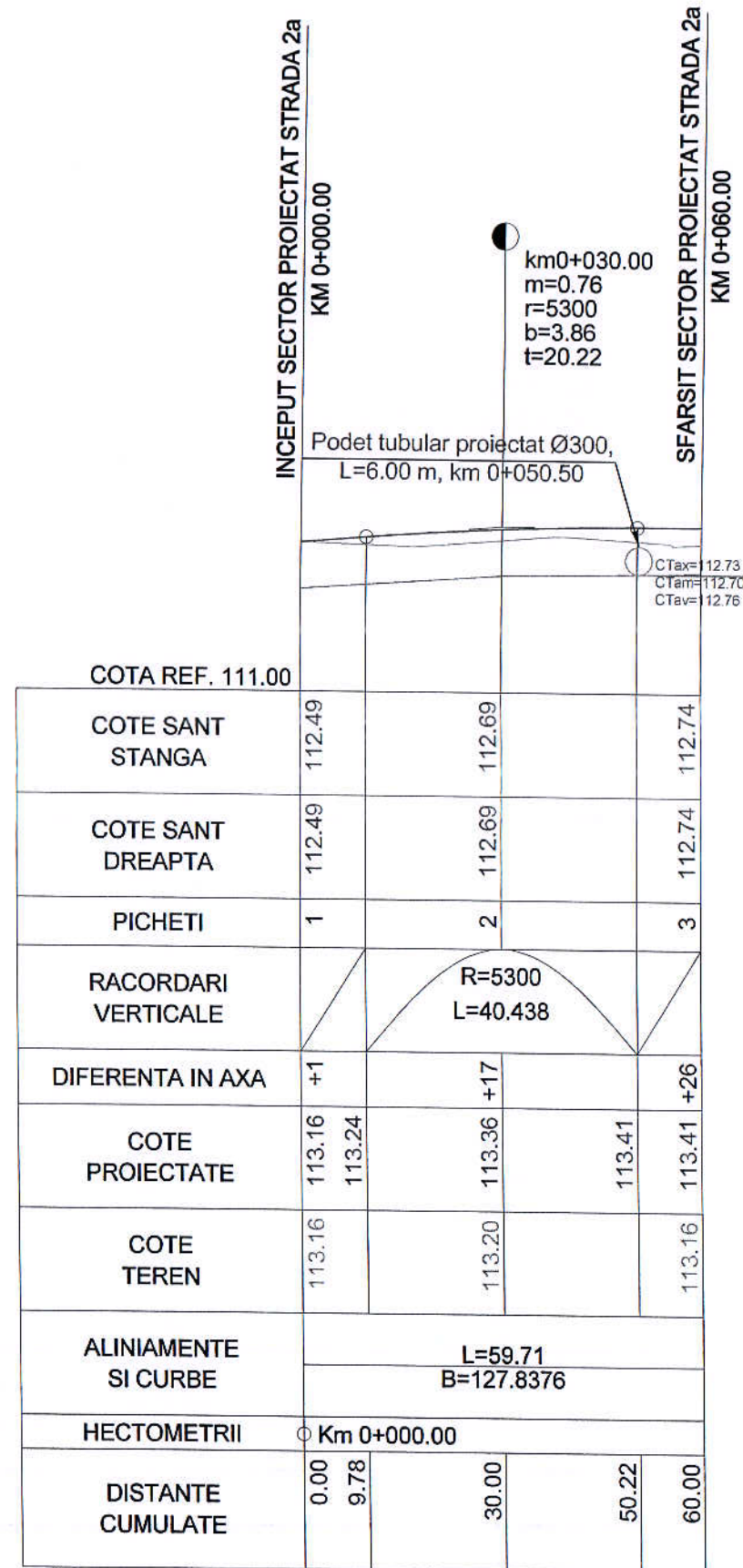

 S.C. "DROMCONS" S.R.L. SEBIS, str. Codrului nr. 1 C.U.I 15624428 J02/9/12/2003 tel : +40(0)743 119 667, tel / fax: +40(0)357 437 554 e-mail : office@dromcons.ro	BENEFICIAR:	COMUNA VLADIMIRESCU	PROIECT NR.
	DENUMIRE PROIECT:	Amenajare străzi zonă locuințe, Vladimirescu zonă nouă, județul Arad	62/2013
SEF PROIECT: dpl. ing. ADRIAN PRAHOVEANU  PROIECTAT Dpl. ing. FLORE CRISTIAN  DESENAT: Dpl. ing. FLORE CRISTIAN 	OBIECT:	DRUMURI	D.T.+C.S.
SCARA:	1:1000 1:100	PROFIL LONGITUDINAL Strada 2a	PLANSĂ NR. 03D-03
	2013		

INCEPUT SECTOR PROIECTAT STRADA 3
KM 0+000.00

km0+030.00
m=1.02
r=4000
b=5.24
t=20.47

km0+180.00
m=0.13

km0+248.96
m=0.10

km0+308.95
m=0.93
r=3300
b=3.58
t=15.37

Podet tubular proiectat Ø300,
L=6.00 m, km 0+180.00

Podet tubular proiectat Ø300,
L=6.00 m, km 0+196.60

CTax=112.61
CTam=112.58
CTav=112.64

CTax=112.59
CTam=112.56
CTav=112.62

COTA REF. 111.00

COTE SANT STANGA	112.80	112.96	112.97	112.94	112.88	112.86	112.77	112.74	112.69	112.61	112.60	112.60	112.60	112.60	112.57	112.52	112.51	112.50	112.49	112.52	112.67				
COTE SANT DREAPTA	112.80	112.96	112.97	112.94	112.88	112.86	112.77	112.74	112.69	112.61	112.60	112.60	112.60	112.60	112.57	112.52	112.51	112.50	112.49	112.52	112.67				
PICHETI	1	2	3	4	5	6	7	8	9	10	11	12	14	15	16	17	18	19	20	21					
RACORDARI VERTICALE		R=4000 L=40.933		L=129.534					P=-0.27%				L=68.956		P=-0.15%		L=44.625		P=-0.05%		R=3300 L=30.740				
DIFERENTA IN AXA	-1	+24	+26	+34	+29	+37	+40	+28	+27	+26	+27	+27	+27	+27	+35	+37	+38	+40	+32	+29	+21				
COTE PROIECTATE	113.47	113.63	113.64	113.63	113.55	113.53	113.44	113.41	113.36	113.28	113.27	113.27	113.27	113.27	113.24	113.19	113.18	113.17	113.16	113.16	113.29				
COTE TEREN	113.47	113.40	113.39	113.27	113.27	113.16	113.05	113.13	113.10	113.02	113.00	113.00	113.00	113.00	112.89	112.82	112.81	112.77	112.84	112.90	113.13				
ALINIAMENTE SI CURBE	L=187.98 B=28.5232										L=1191 R=200.00					L=390.63 B=27.9164									
HECTOMETRII	Km 0+000.00									hm 1						hm 2						hm 3			
DISTANTE CUMULATE	0.00	9.53	28.14	30.00	50.47	60.00	81.23	90.00	120.00	133.82	150.00	180.00	187.98	188.94	188.95	189.89	210.00	240.00	248.96	270.00	293.58	300.00	308.95	324.32	330.00



<p>S.C. "DROMCONS" S.R.L. SEBIS str. Codrului nr. 1 C.U.I 15624426 J029/12/2003 tel :+40(0)743 119 667, tel / fax:+40(0)357 437 554 e-mail : office@dromcons.ro</p>	BENEFICIAR:	COMUNA VLADIMIRESCU	PROIECT NR.
	DENUMIRE PROIECT:	Amenajare străzi zonă locuințe, Vladimirescu zonă nouă, județul Arad	62/2013
	OBIECT:	DRUMURI	D.T.+C.S.
SEF PROIECT:	dpl. Ing. ADRIAN PRAHOVEANU	SCARA:	<p>PROFIL LONGITUDINAL Strada 3</p>
PROIECTAT	Dpl. Ing. FLORE CRISTIAN	1:1000 1:100	
DESENAT:	Dpl. Ing. FLORE CRISTIAN	2013	
			PLANSĂ NR. 03D-04

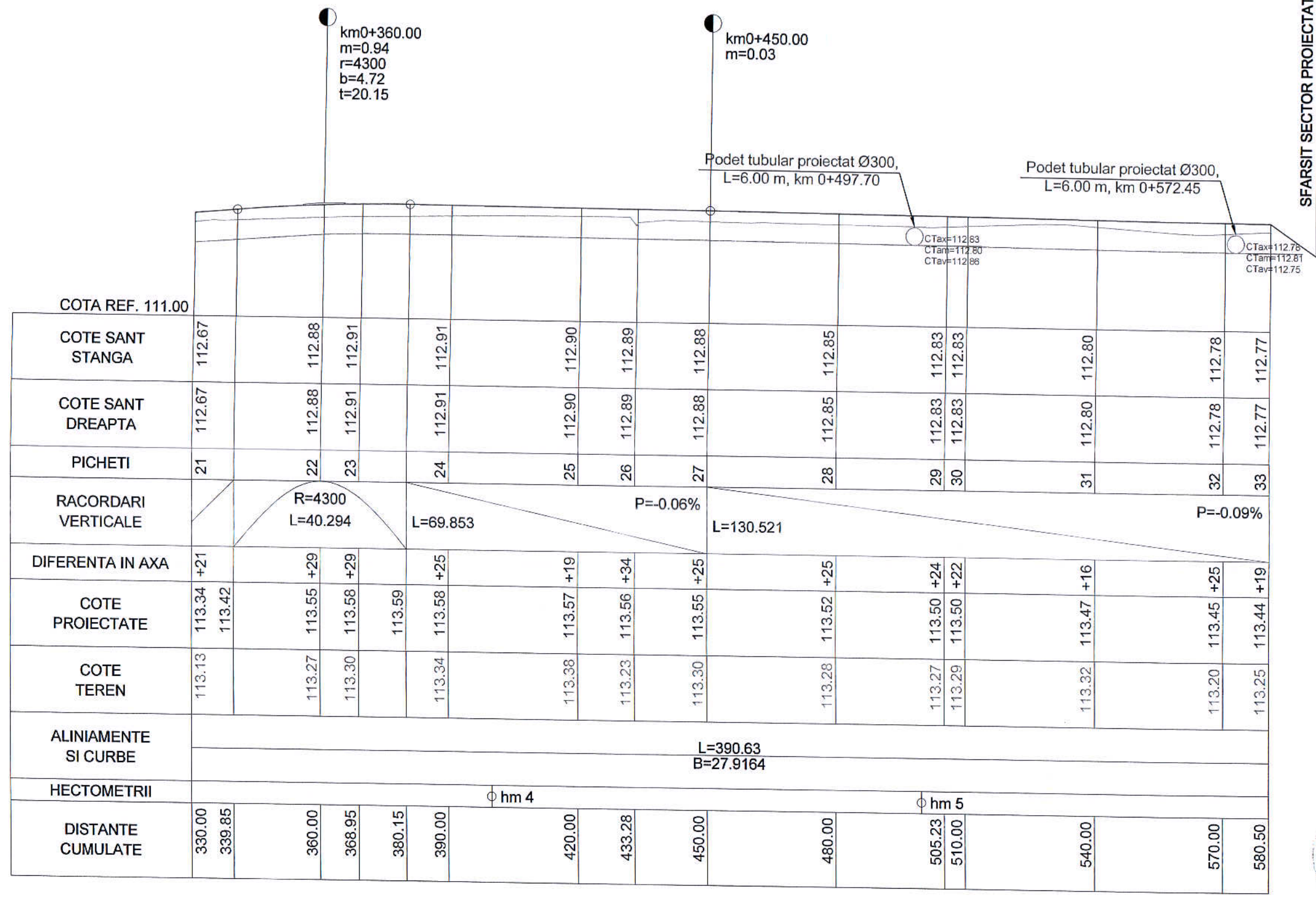

km0+360.00
m=0.94
r=4300
b=4.72
t=20.15

km0+450.00
m=0.03

Podet tubular proiectat Ø300,
L=6.00 m, km 0+497.70

Podet tubular proiectat Ø300,
L=6.00 m, km 0+572.45

CTax=112.83
CTan=112.80
CTav=112.86

CTax=112.78
CTan=112.81
CTav=112.75

SFARSIT SECTOR PROIECTAT STRADA 3
KM 0+580.50



 S.C. "DROMCONS" S.R.L. SEBIS, str. Codrului nr. 1 C.U.I 15624428 J02/9/12/2003 tel : +40(0)743 119 667, tel / fax: +40(0)357 437 554 e-mail : office@dromcons.ro	BENEFICIAR:	COMUNA VLADIMIRESCU	PROIECT NR.
	DENUMIRE PROIECT:	Amenajare străzi zonă locuințe, Vladimirescu zonă nouă, Județul Arad	62/2013
SEF PROIECT:	dpl. ing. ADRIAN PRAHOVEANU	OBIECT:	DRUMURI
PROIECTAT	Dpl. Ing. FLORE CRISTIAN	SCARA:	1:1000 1:100
DESENAT:	Dpl. Ing. FLORE CRISTIAN	2013	PROFIL LONGITUDINAL Strada 3
			D.T.+C.S. PLANSĂ NR. 03D-05

INCEPUT SECTOR PROIECTAT STRADA 4
KM 0+000.00

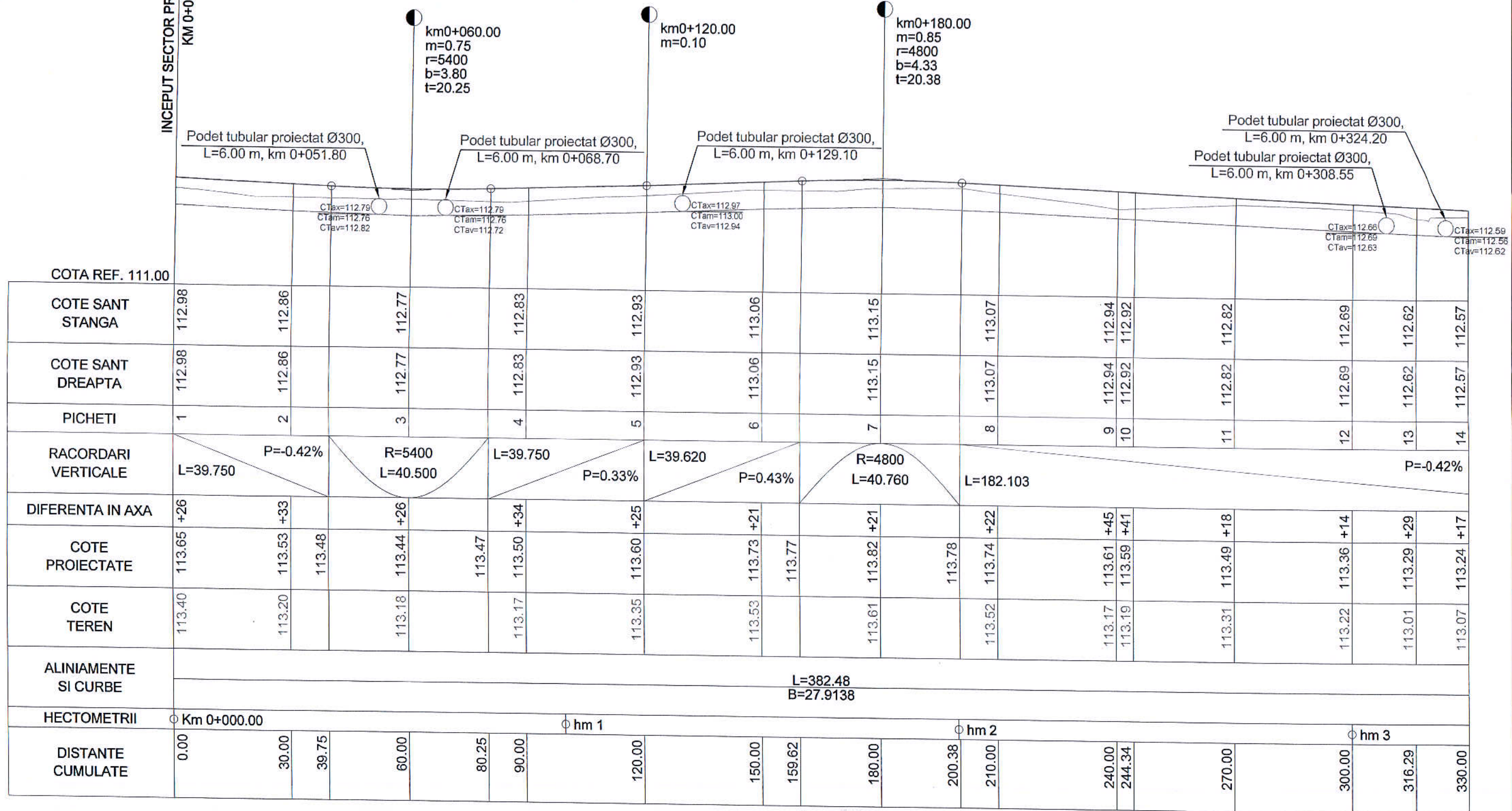

COTA REF. 111.00

km0+060.00
m=0.75
r=5400
b=3.80
t=20.25

km0+120.00
m=0.10

km0+180.00
m=0.85
r=4800
b=4.33
t=20.38

Podet tubular proiectat Ø300,
L=6.00 m, km 0+051.80

Podet tubular proiectat Ø300,
L=6.00 m, km 0+068.70

Podet tubular proiectat Ø300,
L=6.00 m, km 0+129.10

Podet tubular proiectat Ø300,
L=6.00 m, km 0+324.20
Podet tubular proiectat Ø300,
L=6.00 m, km 0+308.55

CTax=112.79
CTam=112.76
CTav=112.82

CTax=112.79
CTam=112.76
CTav=112.72

CTax=112.97
CTam=113.00
CTav=112.94

CTax=112.66
CTam=112.69
CTav=112.63

CTax=112.59
CTam=112.56
CTav=112.62

L=382.48
B=27.9138

HECTOMETRII ○ Km 0+000.00

○ hm 1

○ hm 2

○ hm 3

DISTANTE CUMULATE	0.00	30.00	39.75	60.00	80.25	90.00	120.00	150.00	159.62	180.00	200.38	210.00	240.00	244.34	270.00	300.00	316.29	330.00
-------------------	------	-------	-------	-------	-------	-------	--------	--------	--------	--------	--------	--------	--------	--------	--------	--------	--------	--------



<p>S.C. "DROMCONS" S.R.L. SEBIS, str. Codrului nr. 1 C.U.I 15624428 J02/912/2003 tel : +40(0)743 119 667, tel / fax: +40(0)357 437 554 e-mail : office@dromcons.ro</p>		BENEFICIAR:	COMUNA VLADIMIRESCU	PROIECT NR.	
	DENUMIRE PROIECT:	Amenajare străzi zonă locuințe, Vladimirescu zonă nouă, Județul Arad	62/2013		
	OBIECT:	DRUMURI			
SEF PROIECT:	dpl. Ing. ADRIAN PRAHOVEANU	SCARA:	1:1000 1:100	PROFIL LONGITUDINAL	D.T.+C.S.
PROIECTAT	Dpl. Ing. FLORE CRISTIAN			Strada 4	PLANSA NR. 03D-06
DESENAT:	Dpl. Ing. FLORE CRISTIAN		2013		

SFARSIT SECTOR PROIECTAT STRADA 4
KM 0+282.50

Podet tubular proiectat Ø300,
L=6.00 m, km 0+374.50

CTax=112.38
CTan=112.41
CTav=112.35

COTA REF. 111.00			
COTE SANT STANGA	112.57	112.44	112.35
COTE SANT DREAPTA	112.57	112.44	112.35
PICHETI	14	15	16
RACORDARI VERTICALE	L=182.103		P=-0.42%
DIFERENTA IN AXA	+17	+31	+30
COTE PROIECTATE	113.24	113.11	113.02
COTE TEREN	113.07	112.81	112.72
ALINIAMENTE SI CURBE	L=382.48 B=27.9138		
HECTOMETRII			
DISTANTE CUMULATE	330.00	360.00	382.50



 S.C. "DROMCONS" S.R.L. SEBIS, str. Codrului nr. 1 C.U.I 15624428 J02/912/2003 tel : +40(0)743 119 667, tel / fax: +40(0)357 437 554 e-mail : office@dromcons.ro		BENEFICIAR:	COMUNA VLADIMIRESCU	PROIECT NR.
		DENUMIRE PROIECT:	Amenajare străzi zonă locuințe, Vladimirescu zonă nouă, județul Arad	62/2013
SEF PROIECT:	dpl. ing. ADRIAN PRAHOVEANU	OBIECT:	DRUMURI	D.T.+C.S.
PROIECTAT	Dpl. Ing. FLORE CRISTIAN	SCARA:	PROFIL LONGITUDINAL Strada 4	
DESENAT:	Dpl. Ing. FLORE CRISTIAN	1:1000 1:100 2013		

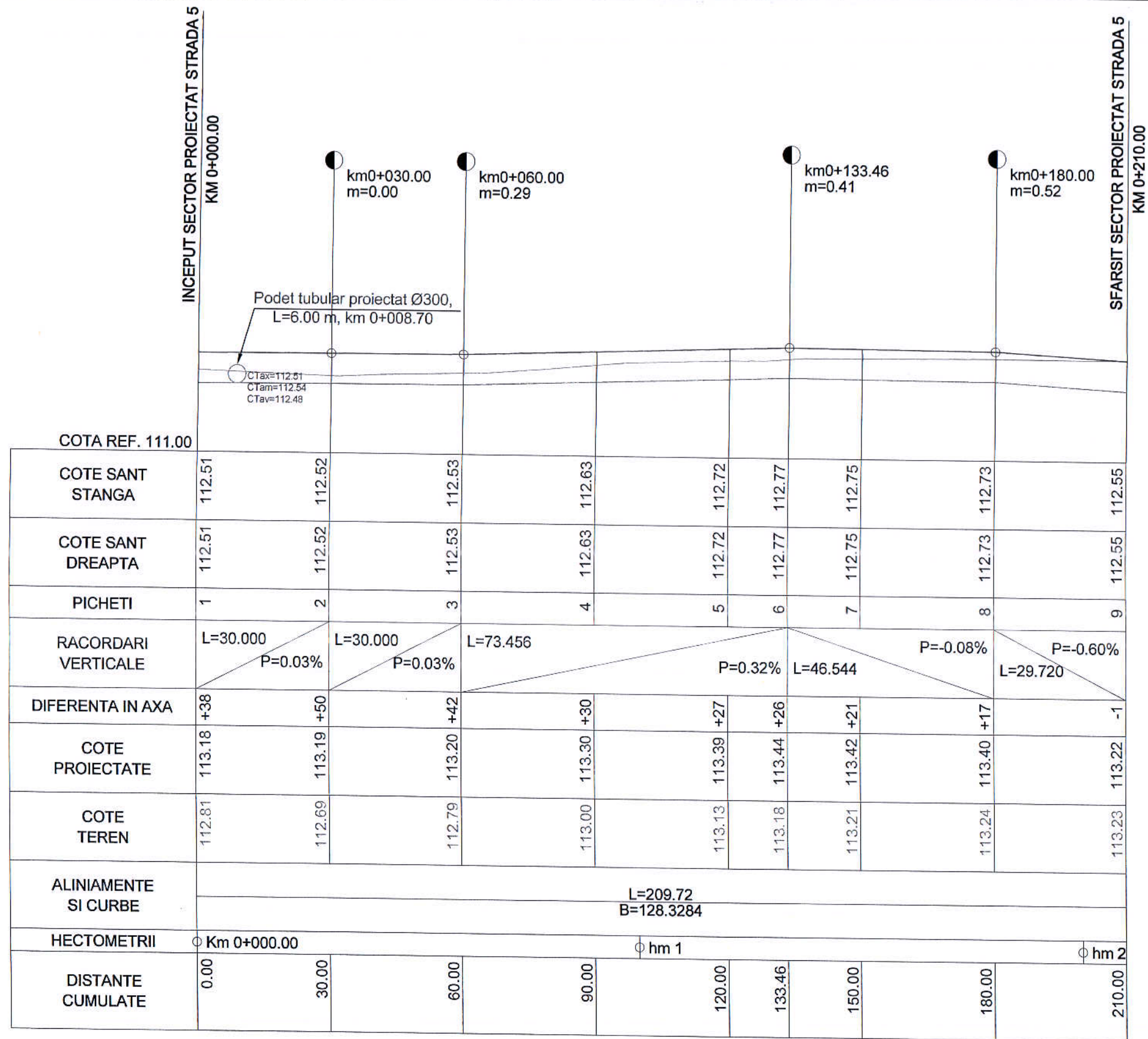

 S.C. "DROMCONS" S.R.L. SEBIS, str. Codrului nr. 1 C.U.I 15624428 J02/912/2003 tel :+40(0)743 119 667, tel / fax:+40(0)357 437 554 e-mail : office@dromcons.ro	BENEFICIAR:	COMUNA VLADIMIRESCU	PROIECT NR.
	DENUMIRE PROIECT:	Amenajare străzi zonă locuințe, Vladimirescu zonă nouă, județul Arad	62/2013
SEF PROIECT:	dpl. ing. ADRIAN PRAHOVEANU	OBIECT:	DRUMURI
PROIECTAT	Dpl. Ing. FLORE CRISTIAN	SCARA:	1:1000 1:100
DESESTAT:	Dpl. Ing. FLORE CRISTIAN	2013	PROFIL LONGITUDINAL Strada 5
			D.T.+C.S. PLANSA NR. 03D-08

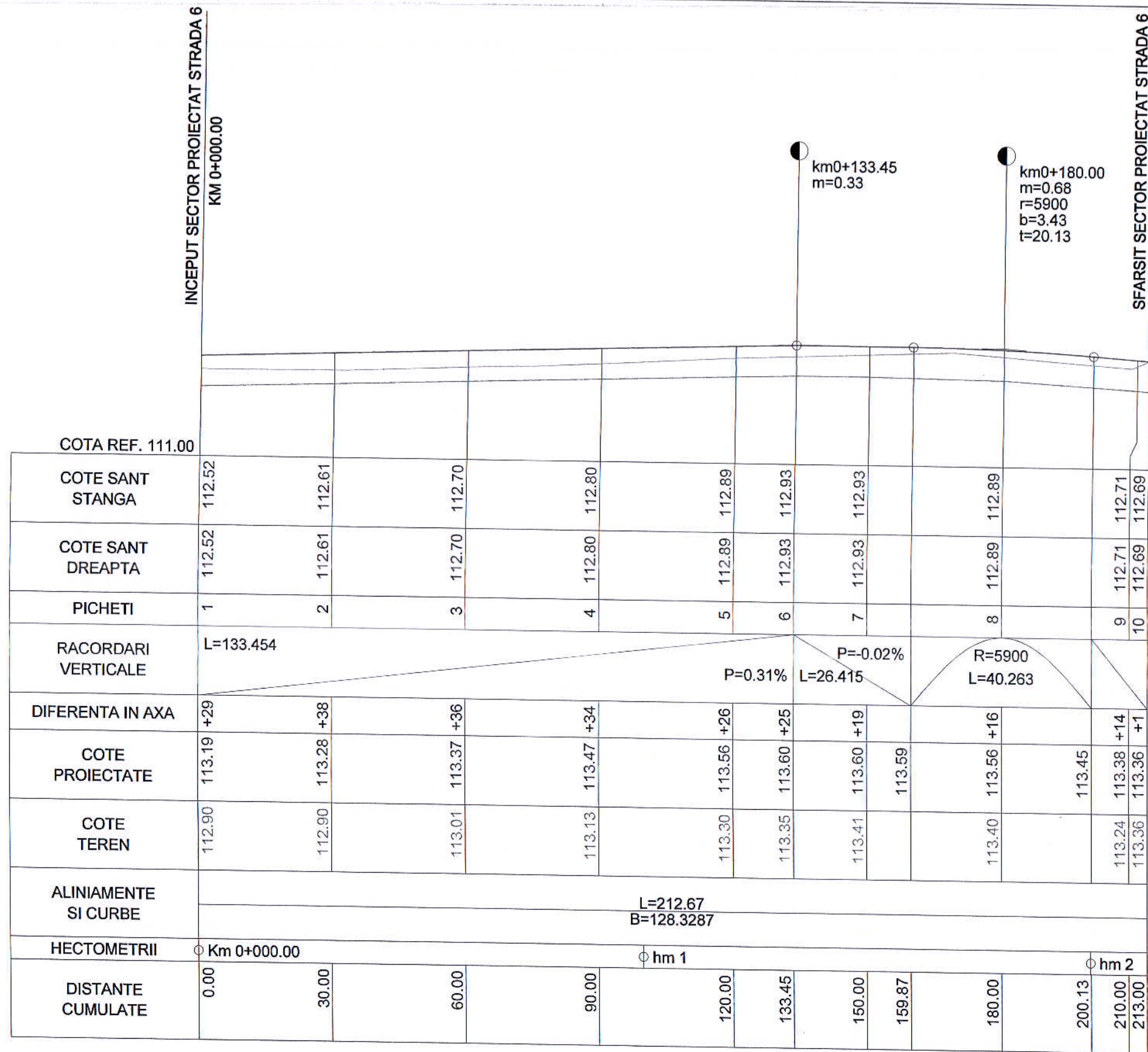

 S.C. "DROMCONS" S.R.L. SEBIS, str. Codrul nr. 1 C.U.I 15624428 J02/912/2003 tel : +40(0)743 119 667, tel / fax: +40(0)357 437 554 e-mail : office@dromcons.ro	BENEFICIAR:	COMUNA VLADIMIRESCU	PROIECT NR.
	DENUMIRE PROIECT:	Amenajare străzi zonă locuințe, Vladimirescu zonă nouă, județul Arad	62/2013
SEF PROIECT:	dpl. ing. ADRIAN PRAHOVEANU	OBIECT:	DRUMURI
PROIECTAT	Dpl. Ing. FLORE CRISTIAN	SCARA:	1:1000 1:100
DESEANAT:	Dpl. Ing. FLORE CRISTIAN	2013	PROFIL LONGITUDINAL Strada 6
			D.T.+C.S. PLANSĂ NR. 03D-09

INCEPUT SECTOR PROIECTAT STRADA 7
KM 0+000.00

SFARSIT SECTOR PROIECTAT STRADA 7
KM 0+215.00

Podet tubular proiectat Ø300,
L=6.00 m, km 0+008.40

km0+133.54
m=0.00

km0+180.00
m=2.40
r=1700
b=12.20
t=20.37

COTA REF. 111.00

COTE SANT STANGA	112.91	112.96	113.02	113.07	113.12	113.15	113.18	113.11	112.56	112.45			
COTE SANT DREAPTA	112.91	112.96	113.02	113.07	113.12	113.15	113.18	113.11	112.56	112.45			
PICHETI	1	2	3	4	5	6	7	8	9	10			
RACORDARI VERTICALE	L=133.542					L=26.093 P=0.18%		R=1700 L=40.731					
DIFERENTA IN AXA	+29	+29	+31	+31	+31	+21	+4	+14	+9	-1			
COTE PROIECTATE	113.58	113.63	113.69	113.74	113.79	113.82	113.85	113.78	113.23	113.12			
COTE TEREN	113.30	113.35	113.38	113.43	113.49	113.61	113.81	113.64	113.15	113.12			
ALINIAMENTE SI CURBE	L=215.04 B=128.3287												
HECTOMETRII	Km 0+000.00					hm 1				hm 2			
DISTANTE CUMULATE	0.00	30.00	60.00	90.00	120.00	133.45	133.54	150.00	159.63	180.00	200.37	210.00	215.00

CTax=112.92
CTam=112.95
CTav=112.49



 <p>S.C. "DROMCONS" S.R.L. SEBIS, str. Codrului nr. 1 C.U.I 15624428 J02/9/12/2003 tel : +40(0)743 119 667, tel / fax: +40(0)357 437 554 e-mail : office@dromcons.ro</p>	BENEFICIAR:	COMUNA VLADIMIRESCU	PROIECT NR.
	DENUMIRE PROIECT:	Amenajare străzi zonă locuințe, Vladimirescu zonă nouă, județul Arad	62/2013
SEF PROIECT:	dpl. ing. ADRIAN PRAHOVEANU	OBIECT:	DRUMURI
PROIECTAT	Dpl. Ing. FLORE CRISTIAN	SCARA:	1:1000 1:100
DESENAT:	Dpl. Ing. FLORE CRISTIAN	PROFIL LONGITUDINAL Strada 7	
			D.T.+C.S. PLANSĂ NR. 03D-10

INCEPUT SECTOR PROIECTAT STRADA 8
KM 0+000.00

Podet tubular proiectat Ø300,
L=6.00 m, km 0+172.60

Podet tubular proiectat Ø300,
L=6.00 m, km 0+191.10

km0+236.37
m=0.02

COTA REF. 111.00																		
COTE SANT STANGA	112.84	112.85	112.85	112.86	112.86	112.87	112.87	112.88	112.88	112.88	112.89	112.89	112.90	112.90	112.92	112.93		
COTE SANT DREAPTA	112.84	112.85	112.85	112.86	112.86	112.87	112.87	112.88	112.88	112.88	112.89	112.89	112.90	112.90	112.92	112.93		
PICHETI	1	2	3	4	5	6	7	8	9	10	11	12	13	14	15			
RACORDARI VERTICALE	L=236.374											L=113.180		P=0.02%		P=0.05%		
DIFERENTA IN AXA	-1	+14	+27	+29	+21	+18	+18	+16	+15	+25	+34	+17	+20	+30	+39			
COTE PROIECTATE	113.51	113.52	113.52	113.53	113.53	113.54	113.54	113.55	113.55	113.55	113.56	113.56	113.57	113.59	113.60			
COTE TEREN	113.51	113.39	113.26	113.24	113.33	113.36	113.37	113.39	113.40	113.31	113.23	113.40	113.38	113.29	113.22			
ALINIAMENTE SI CURBE	L=162.87 B=130.3841											L=291.09 B=130.3841						
HECTOMETRII	Km 0+000.00					hm 1					hm 2					hm 3		
DISTANTE CUMULATE	0.00	30.00	60.00	90.00	120.00	150.00	162.87	180.00	181.56	210.00	236.37	240.00	270.00	300.00	330.00			



<p>S.C. "DROMCONS" S.R.L. SEBIS, str. Codrului nr. 1 C.U.I 15624428 J02/912/2003 tel : +40(0)743 119 667, tel / fax: +40(0)357 437 554 e-mail : office@dromcons.ro</p>	BENEFICIAR:	COMUNA VLADIMIRESCU	PROIECT NR.
	DENUMIRE PROIECT:	Amenajare străzi zonă locuințe, Vladimirescu zonă nouă, județul Arad	62/2013
	OBIECT:	DRUMURI	D.T.+C.S.
	SCARA:	1:1000 1:100 2013	PLANSA NR. 03D-11
SEF PROIECT:	dpl. ing. ADRIAN PRAHOVEANU	PROFIL LONGITUDINAL Strada 8	
PROIECTAT	Dpl. Ing. FLORE CRISTIAN		
DESEMAT:	Dpl. Ing. FLORE CRISTIAN		

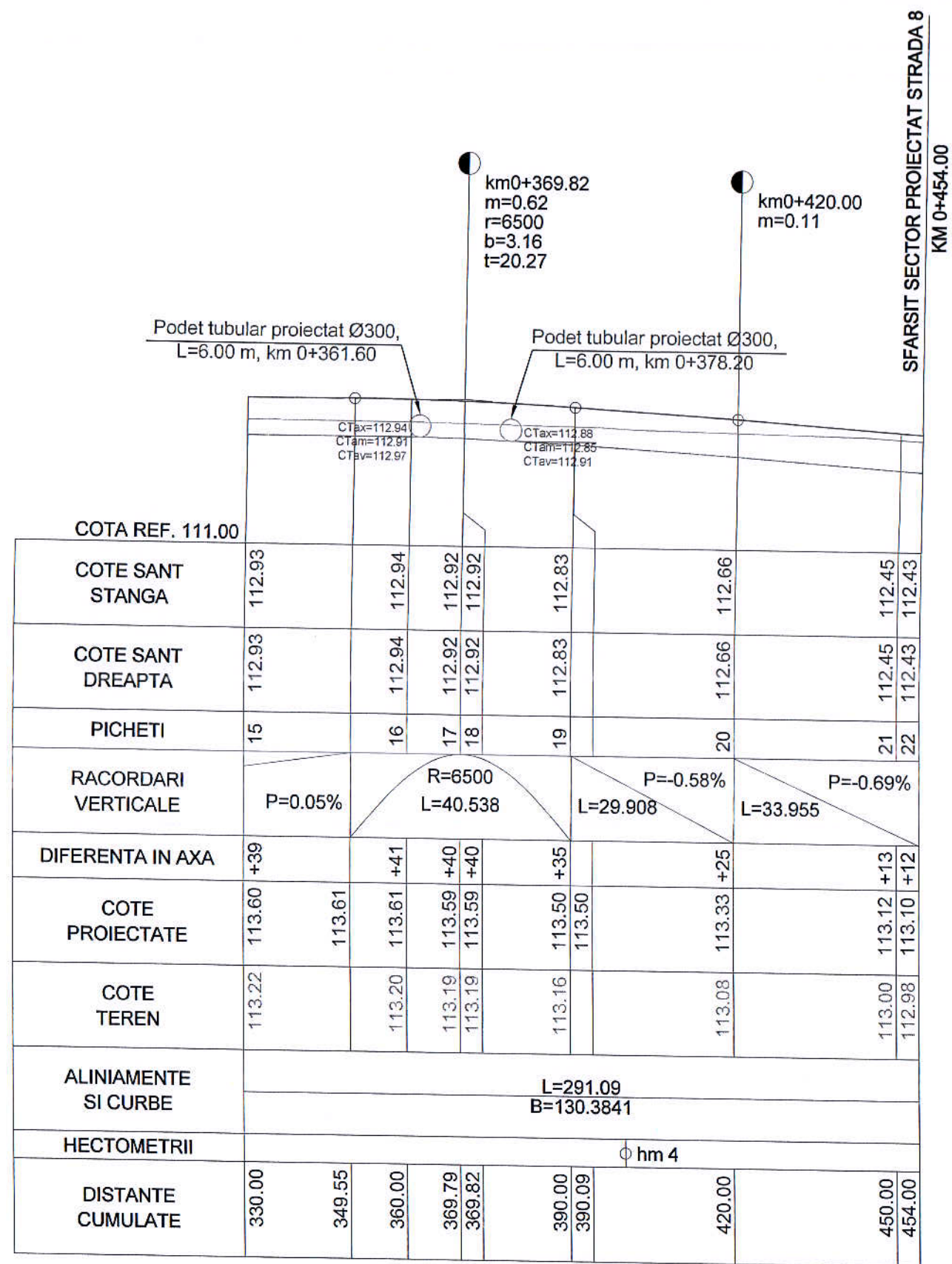

SFARSIT SECTOR PROIECTAT STRADA 8
KM 0+454.00



 <p>S.C. "DROMCONS" S.R.L. SEBIS, str. Codrul nr. 1 C.U.I 15624428 J02/912/2003 tel : +40(0)743 119 667, tel / fax: +40(0)357 437 554 e-mail : office@dromcons.ro</p>	BENEFICIAR:	COMUNA VLADIMIRESCU	PROIECT NR.
	DENUMIRE PROIECT:	Amenajare străzi zonă locuințe, Vladimirescu zonă nouă, județul Arad	62/2013
	OBIECT:	DRUMURI	
	SEF PROIECT:	dpl. Ing. ADRIAN PRAHOVEANU	SCARA:
PROIECTAT	Dpl. Ing. FLORE CRISTIAN	1:1000 1:100	PROFIL LONGITUDINAL Strada 8
DESESTAT:	Dpl. Ing. FLORE CRISTIAN	2013	

INCEPUT SECTOR PROIECTAT STRADA 9
KM 0+000.00

SFARSIT SECTOR PROIECTAT STRADA 9
KM 0+265.50

COTA REF. 111.00											
COTE SANT STANGA	112.83	112.78	112.74	112.69	112.64	112.62	112.55	112.41	112.27	112.14	112.02
COTE SANT DREAPTA	112.83	112.78	112.74	112.69	112.64	112.62	112.55	112.41	112.27	112.14	112.02
PICHETI	1	2	3	4	5	6	7	8	9	10	11
RACORDARI VERTICALE	L=133.446					P=-0.16%		L=132.000			P=-0.45%
DIFERENTA IN AXA	+24	+17	+18	+16	+18	+29	+17	+24	+33	+24	+14
COTE PROIECTATE	113.50	113.45	113.41	113.36	113.31	113.29	113.22	113.08	112.94	112.81	112.69
COTE TEREN	113.27	113.29	113.23	113.21	113.13	113.01	113.05	112.84	112.62	112.58	112.55
ALINIAMENTE SI CURBE	L=265.45 B=128.3287										
HECTOMETRII	○ Km 0+000.00			○ hm 1				○ hm 2			
DISTANTE CUMULATE	0.00	30.00	60.00	90.00	120.00	133.45	150.00	180.00	210.00	240.00	265.50



 S.C. "DROMCONS" S.R.L. SEBIS, str. Codrului nr. 1 C.U.I 15624428 J02/9/12/2003 tel : +40(0)743 119 667 tel / fax: +40(0)357 437 554 e-mail : office@dromcons.ro	BENEFICIAR: COMUNA VLADIMIRESCU		PROIECT NR.
	DENUMIRE PROIECT: Amenajare străzi zonă locuințe, Vladimirescu zonă nouă, județul Arad		62/2013
SEF PROIECT: dpl. ing. ADRIAN PRAHOVEANU		OBIECT: DRUMURI	
PROIECTAT Dpl. Ing. FLORE CRISTIAN		SCARA: 1:1000 1:100	D.T.+C.S.
DESENAT: Dpl. Ing. FLORE CRISTIAN			
PROFIL LONGITUDINAL Strada 9			PLANSĂ NR. 03D-13

INCEPUT SECTOR PROIECTAT STRADA 10
KM 0+000.00

km0+030.00
m=0.90
r=2300
b=2.35
t=10.39

km0+120.00
m=0.06

km0+210.00
m=0.12

km0+330.00
m=0.79
r=5100
b=3.95
t=20.07

COTA REF. 111.00																						
COTE SANT STANGA	112.28		112.57		112.63		112.67		112.71		112.73		112.76		112.77		112.76		112.74		112.69	
COTE SANT DREAPTA	112.28		112.57		112.63		112.67		112.71		112.73		112.76		112.77		112.76		112.74		112.69	
PICHETI	1		2		3		4		5		6		7		8		9		10		11	12
RACORDARI VERTICALE	P=1.04%		L=79.611		P=0.13%		L=89.999		P=0.08%		L=99.934		P=-0.04%									
DIFERENTA IN AXA	+1		+25		+25		+27		+25		+19		+42		+31		+20		+21		+19	+25
COTE PROIECTATE	112.95	113.15	113.24	113.27	113.30	113.34	113.38	113.40	113.43	113.45	113.44	113.43	113.41	113.41	113.36							
COTE TEREN	112.95		112.99		113.05		113.08		113.13		113.22		113.02		113.15		113.24		113.22		113.23	113.12
ALINIAMENTE SI CURBE	L=379.27 B=132.6567																					
HECTOMETRII	○ Km 0+000.00												○ hm 1				○ hm 2				○ hm 3	
DISTANTE CUMULATE	0.00	19.61	30.00	40.39	60.00	90.00	120.00	150.00	180.00	210.00	240.00	270.00	300.00	309.93	330.00							



 <p>S.C. "DROMCONS" S.R.L. SEBIS, str. Codrului nr. 1 C.U.J 15624428 J02/912/2003 tel : +40(0)743 119 667, tel / fax: +40(0)357 437 554 e-mail : office@dromcons.ro</p>	BENEFICIAR:	COMUNA VLADIMIRESCU	PROIECT NR.
	DENUMIRE PROIECT:	Amenajare străzi zonă locuințe, Vladimirescu zonă nouă, județul Arad	62/2013
SEF PROIECT:	dpl. ing. ADRIAN PRAHOVEANU	OBIECT:	DRUMURI
PROIECTAT	Dpl. Ing. FLORE CRISTIAN	SCARA:	1:1000 1:100
DESENAT:	Dpl. Ing. FLORE CRISTIAN	PROFIL LONGITUDINAL Strada 10	
			D.T.+C.S. PLANSA NR. 03D-14

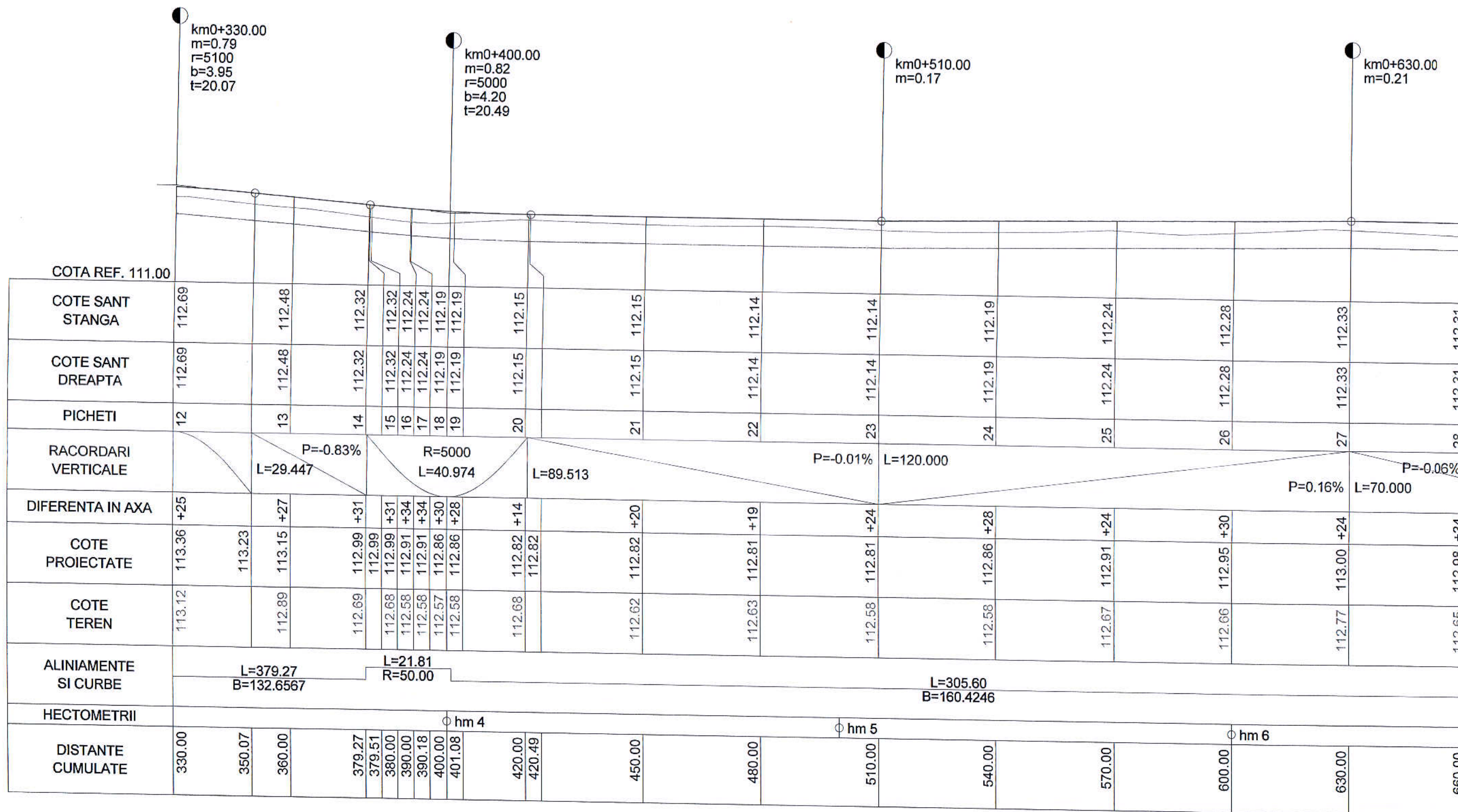

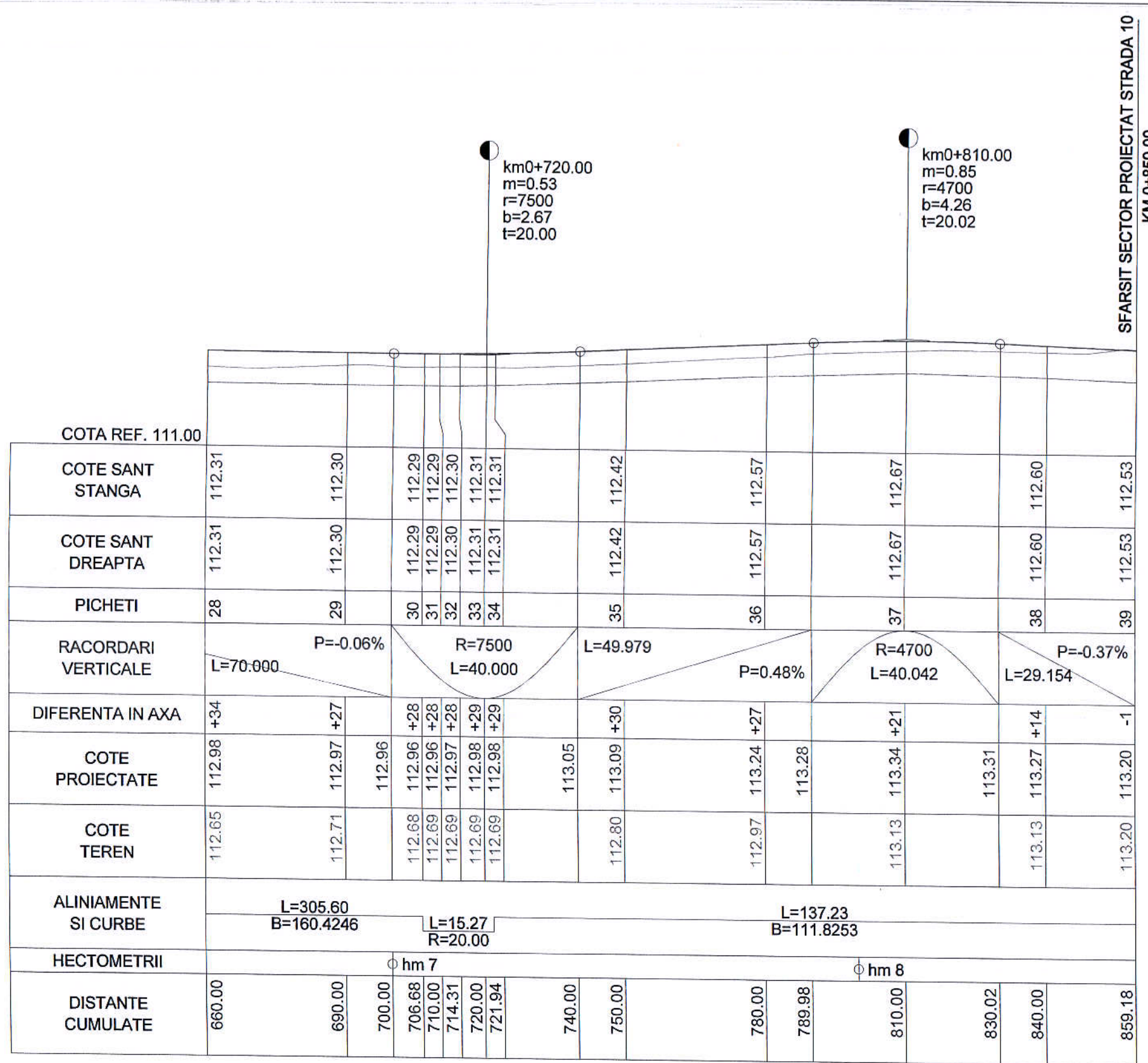

<p>S.C. "DROMCONS" S.R.L. SEBIS str. Codrului nr. 1 C.U.I 15624428 J02/912/2003 tel : +40(0)743 119 667, tel / fax: +40(0)357 437 554 e-mail : office@dromcons.ro</p>	BENEFICIAR:	COMUNA VLADIMIRESCU	PROIECT NR.
	DENUMIRE PROIECT:	Amenajare străzi zonă locuințe, Vladimirescu zonă nouă, județul Arad	62/2013
	OBIECT:	DRUMURI	
SEF PROIECT:	dpl. ing. ADRIAN PRAHOVEANU	SCARA:	
PROIECTAT	Dpl. Ing. FLORE CRISTIAN	1:1000 1:100	D.T.+C.S.
DESESTAT:	Dpl. Ing. FLORE CRISTIAN	2013	PLANSĂ NR. 03D-15
PROFIL LONGITUDINAL			
Strada 10			



SFARSIT SECTOR PROIECTAT STRADA 10
KM 0+859.00



 <p>SEBIS, str. Codrului nr. 1 C.U.I 15624428 J02/912/2003 tel : +40(0)743 119 667, tel / fax: +40(0)357 437 554 e-mail : office@dromcons.ro</p>	S.C. "DROMCONS" S.R.L.		BENEFICIAR:	COMUNA VLADIMIRESCU	PROIECT NR.
			DENUMIRE PROIECT:	Amenajare străzi zonă locuințe, Vladimirescu zonă nouă, județul Arad	62/2013
	SEF PROIECT:	dpl. ing. ADRIAN PRAHOVEANU	SCARA:	DRUMURI	D.T.+C.S.
PROIECTAT	Dpl. ing. FLORE CRISTIAN	1:1000 1:100	PROFIL LONGITUDINAL Strada 10		PLANSĂ NR. 03D-15
DESENAT:	Dpl. ing. FLORE CRISTIAN	2013			

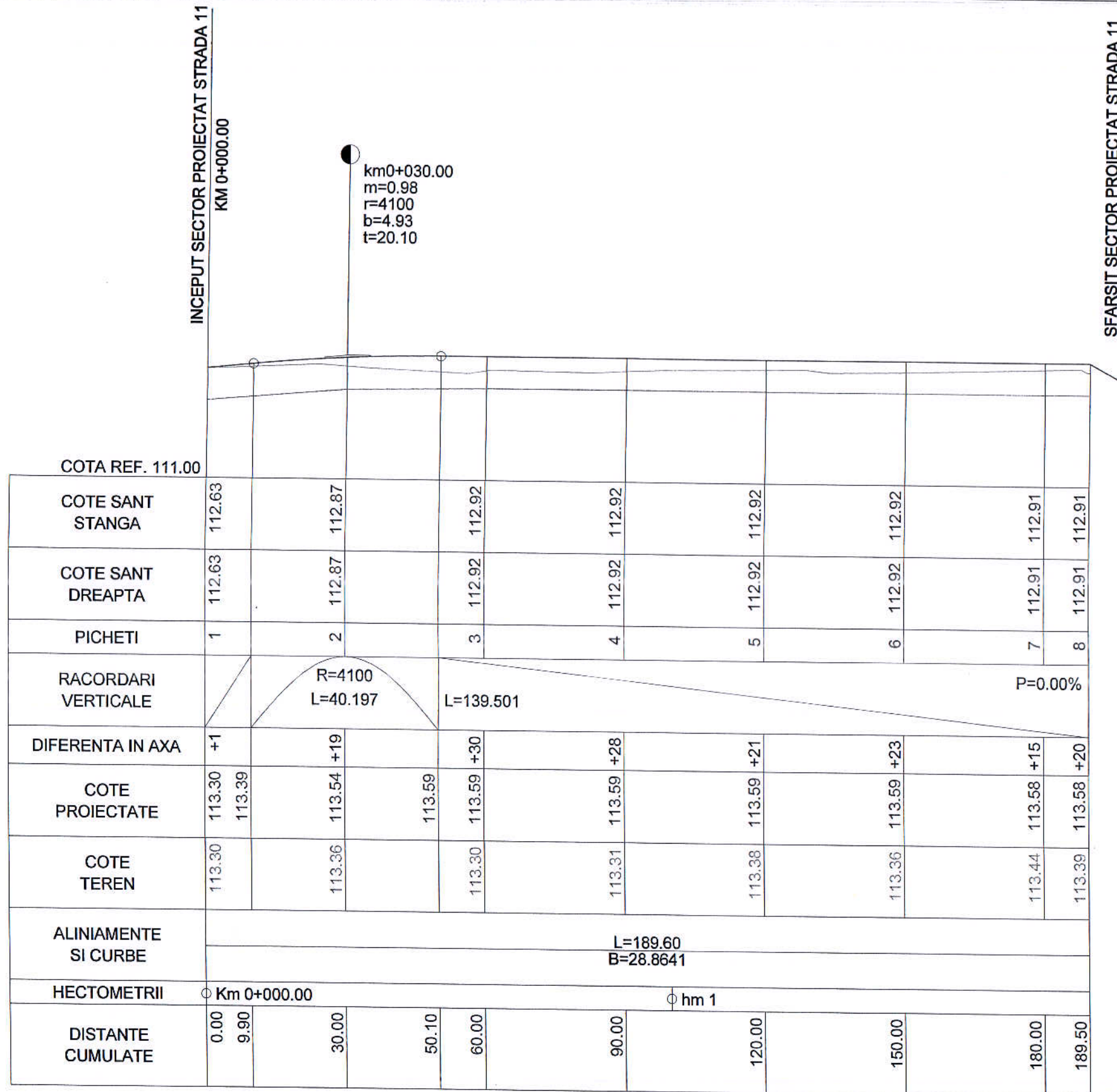

SFARSIT SECTOR PROIECTAT STRADA 11
KM 0+189.60



 S.C. "DROMCONS" S.R.L. SEBIS, str. Codrului nr. 1 C.U.I 15624428 J02/912/2003 tel : +40(0)743 119 667, tel / fax: +40(0)357 437 554 e-mail : office@dromcons.ro	BENEFICIAR:	COMUNA VLADIMIRESCU	PROIECT NR.
	DENUMIRE PROIECT:	Amenajare străzi zonă locuințe, Vladimirescu zonă nouă, județul Arad	62/2013
SEF PROIECT:	dpl. ing. ADRIAN PRAHOVEANU	OBIECT:	DRUMURI
PROIECTAT	Dpl. Ing. FLORE CRISTIAN	SCARA:	1:1000 1:100
DESENAT:	Dpl. Ing. FLORE CRISTIAN	2013	PROFIL LONGITUDINAL Strada 11
			D.T.+C.S. PLANSA NR. 03D-17

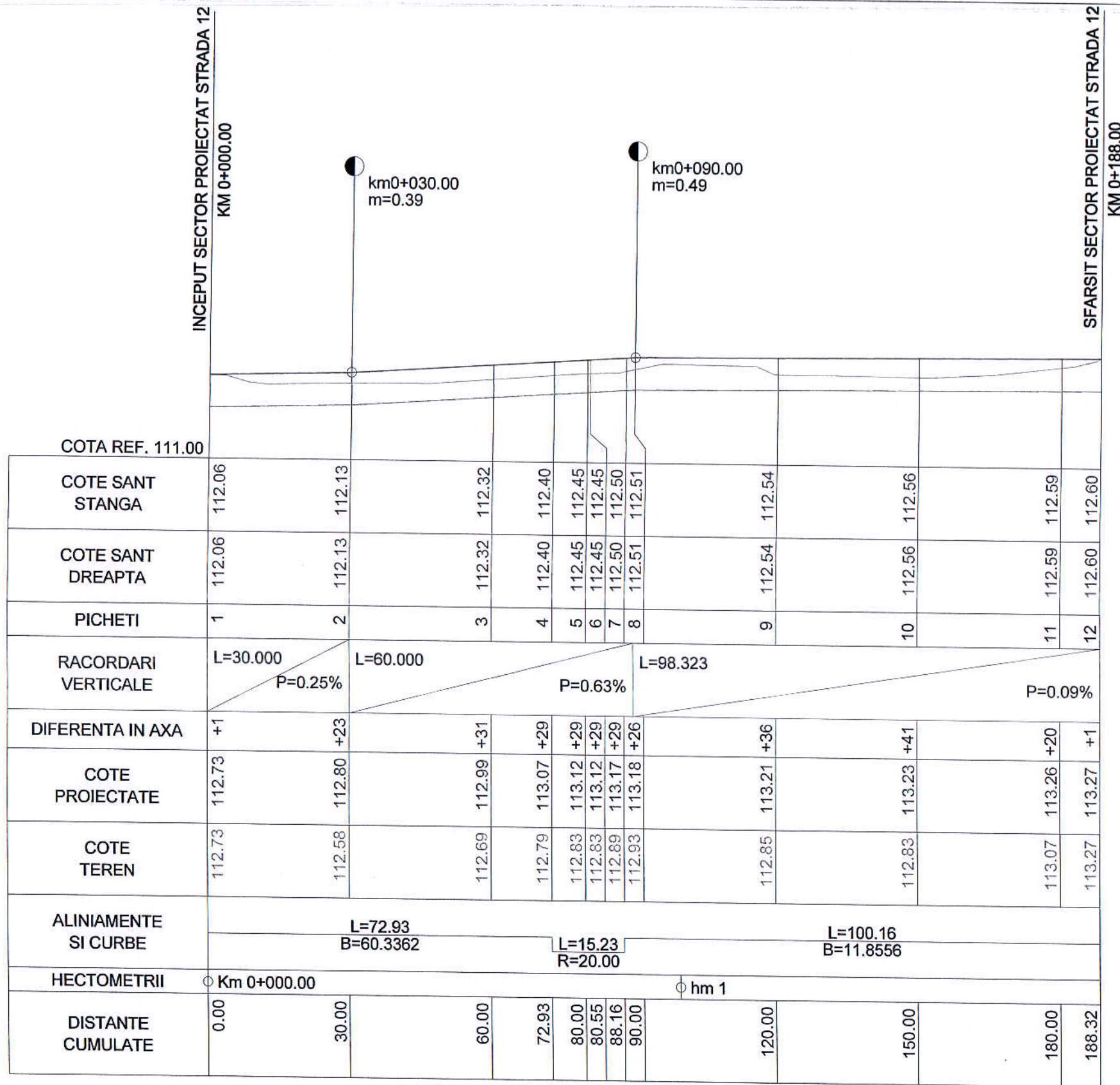

 S.C. "DROMCONS" S.R.L. SEBIS, str. Codrului nr. 1 C.U.I 15624428 J02/912/2003 tel : +40(0)743 119 667, tel / fax: +40(0)357 437 554 e-mail : office@dromcons.ro	BENEFICIAR: COMUNA VLADIMIRESCU		PROIECT NR.
	DENUMIRE PROIECT: Amenajare străzi zonă locuințe, Vladimirescu zonă nouă, județul Arad		62/2013
	OBIECT: DRUMURI		
SEF PROIECT: dpl. ing. ADRIAN PRAHOVEANU	SCARA: 1:1000 1:100	PROFIL LONGITUDINAL Strada 12	
PROIECTAT: Dpl. Ing. FLORE CRISTIAN	2013		
DESENAT: Dpl. Ing. FLORE CRISTIAN		D.T.+C.S. PLANSA NR. 03D-18	

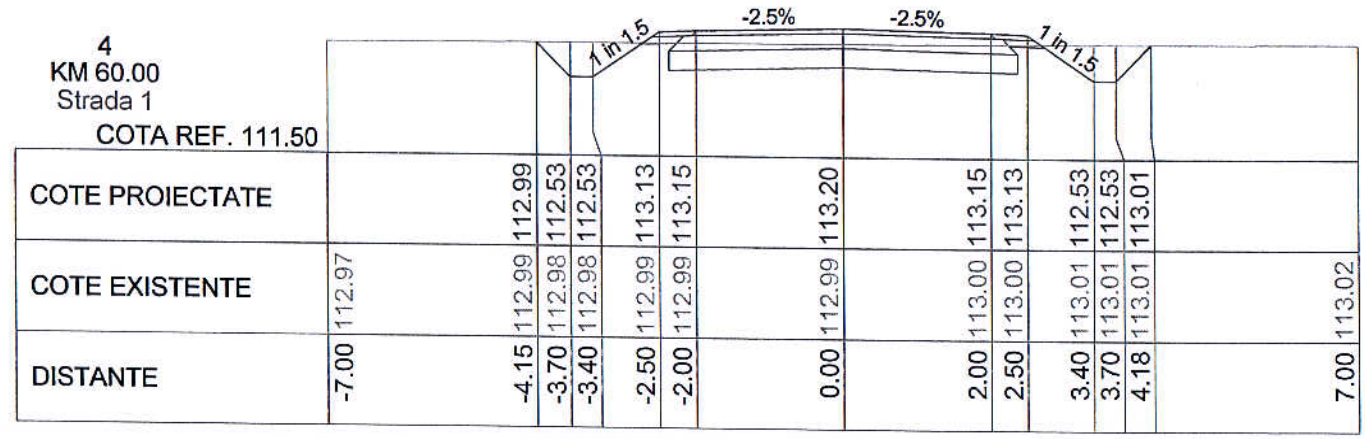
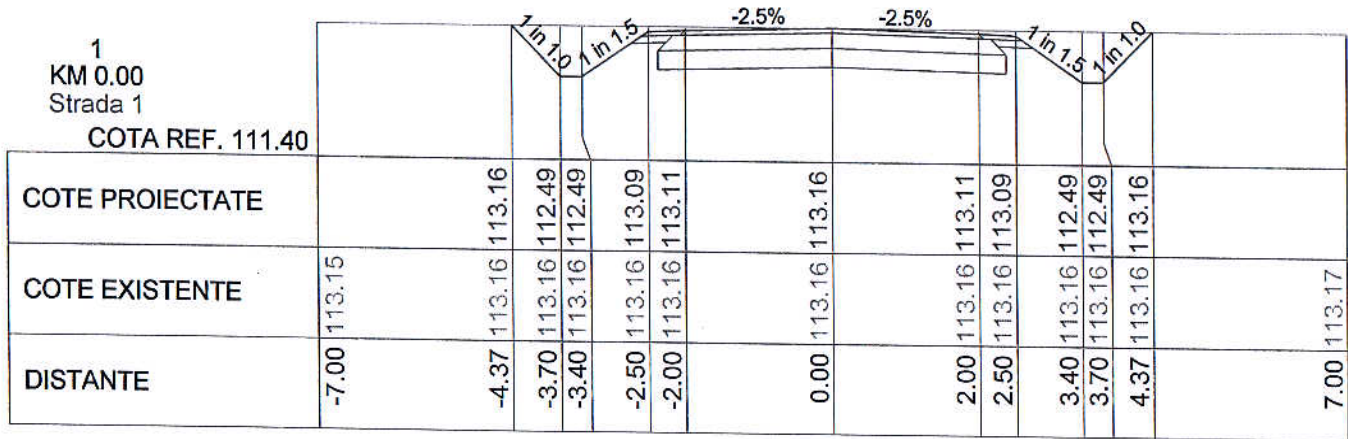
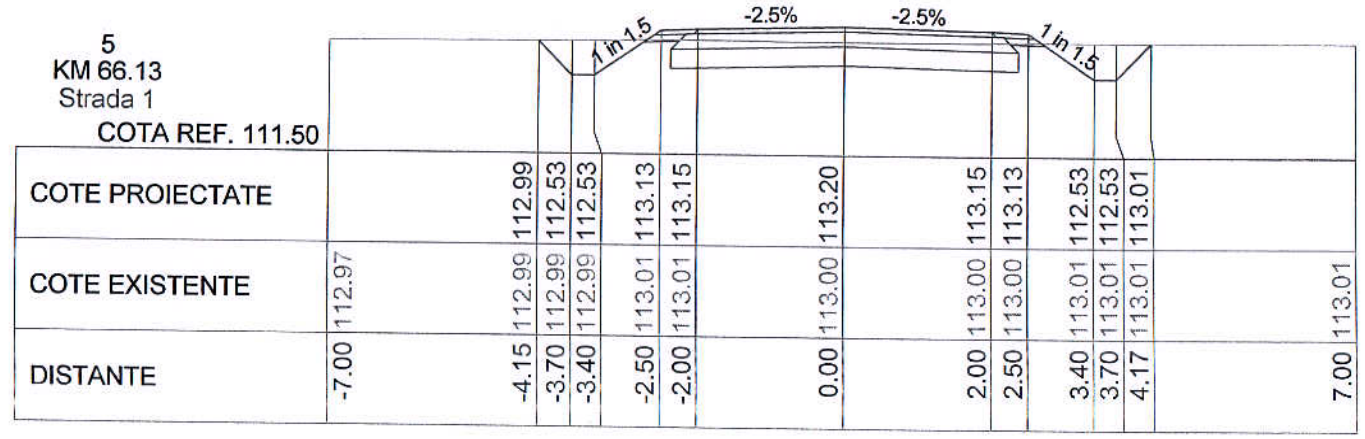
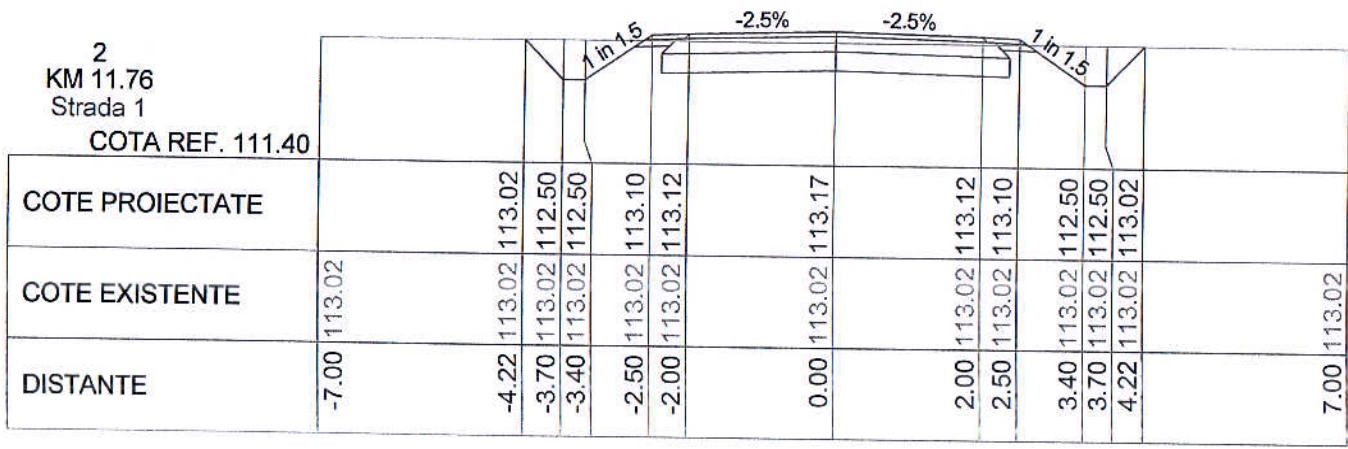
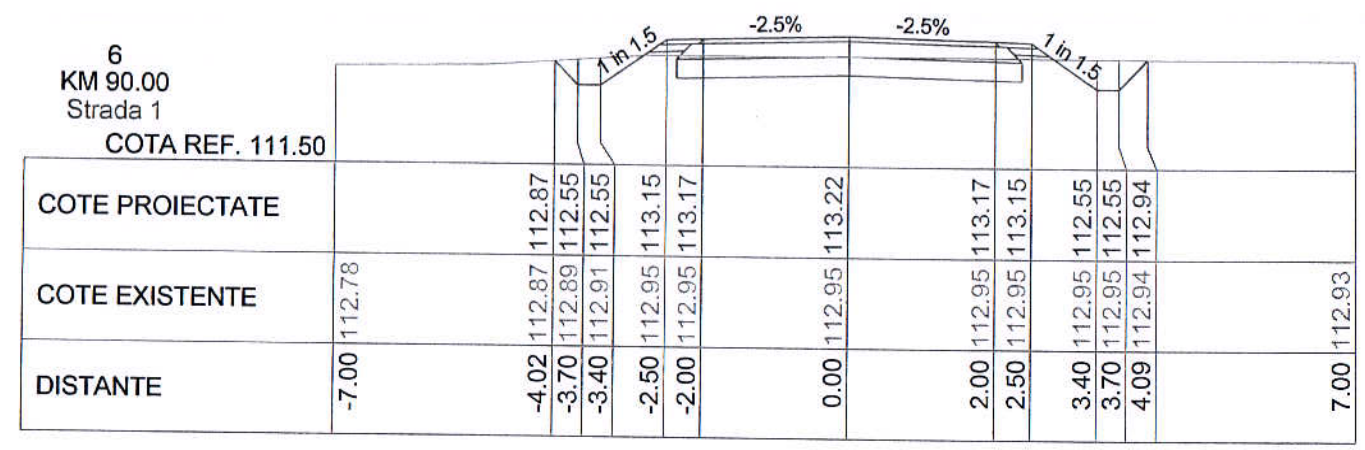
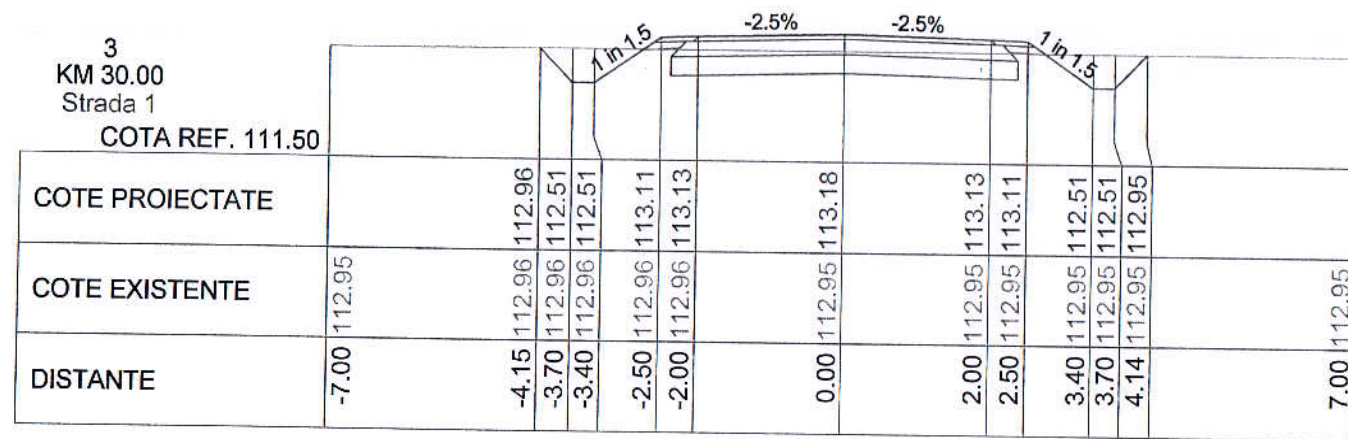

 S.C. "DROMCONS" S.R.L. SEBIS, str. Codrul nr. 1 C.U.I 15624428 J02/912/2003 tel : +40(0)743 119 667, tel / fax: +40(0)357 437 554 e-mail : office@dromcons.ro		BENEFICIAR:	COMUNA VLADIMIRESCU	PROIECT NR.	
SEF PROIECT:	dpl. ing. ADRIAN PRAHOVEANU	DENUMIRE PROIECT:	Amenajare străzi zonă locuințe, Vladimirescu zonă nouă, județul Arad		62/2013
PROIECTAT	Dpl. Ing. FLORE CRISTIAN	OBIECT:	DRUMURI		D.T.+C.S.
DESEMAT:	Dpl. Ing. FLORE CRISTIAN	SCARA:	1:1000 1:100	PROFILURI TRANSVERSALE CURENTE Strada 1	PLANSĂ NR. 03D-01
			2013		

9
KM 180.00
Strada 1
COTA REF. 111.90

COTE PROIECTATE																							
COTE EXISTENTE	-7.00																					113.27	
DISTANTE		-4.09	-3.70	-3.40	-2.50	-2.00	0.00	2.00	2.50	3.40	3.70	4.03											7.00

12
KM 240.00
Strada 1
COTA REF. 111.90

COTE PROIECTATE																								
COTE EXISTENTE	-7.00																						113.33	
DISTANTE		-4.11	-3.70	-3.40	-2.50	-2.00	0.00	2.00	2.50	3.40	3.70	4.16												7.00

8
KM 150.00
Strada 1
COTA REF. 111.70

COTE PROIECTATE																								
COTE EXISTENTE	-7.00																						113.22	
DISTANTE		-4.11	-3.70	-3.40	-2.50	-2.00	0.00	2.00	2.50	3.40	3.70	4.19												7.00

11
KM 210.00
Strada 1
COTA REF. 111.90

COTE PROIECTATE																								
COTE EXISTENTE	-7.00																						113.30	
DISTANTE		-4.10	-3.70	-3.40	-2.50	-2.00	0.00	2.00	2.50	3.40	3.70	4.05												7.00

7
KM 120.00
Strada 1
COTA REF. 111.60

COTE PROIECTATE																								
COTE EXISTENTE	-7.00																						112.96	
DISTANTE		-4.05	-3.70	-3.40	-2.50	-2.00	0.00	2.00	2.50	3.40	3.70	4.05												7.00

10
KM 199.59
Strada 1
COTA REF. 111.90

COTE PROIECTATE																								
COTE EXISTENTE	-7.00																						113.34	
DISTANTE		-4.08	-3.70	-3.40	-2.50	-2.00	0.00	2.00	2.50	3.40	3.70	4.12												7.00



 S.C. "DROMCONS" S.R.L. SEBIS, str. Codrului nr. 1 C.U.I 15624428 J02/912/2003 tel : +40(0)743 119 667, tel / fax: +40(0)357 437 554 e-mail : office@dromcons.ro	BENEFICIAR:	COMUNA VLADIMIRESCU	PROIECT NR.
	DENUMIRE PROIECT:	Amenajare străzi zonă locuințe, Vladimirescu zonă nouă, județul Arad	62/2013
	OBIECT:	DRUMURI	D.T.+C.S.
SEF PROIECT:	dpl. ing. ADRIAN PRAHOVEANU	SCARA:	PROFILURI TRANSVERSALE CURENTE Strada 1 PLANSĂ NR. 03D-02
PROIECTAT	Dpl. Ing. FLORE CRISTIAN	1:1000 1:100	
DESENAT:	Dpl. Ing. FLORE CRISTIAN	2013	

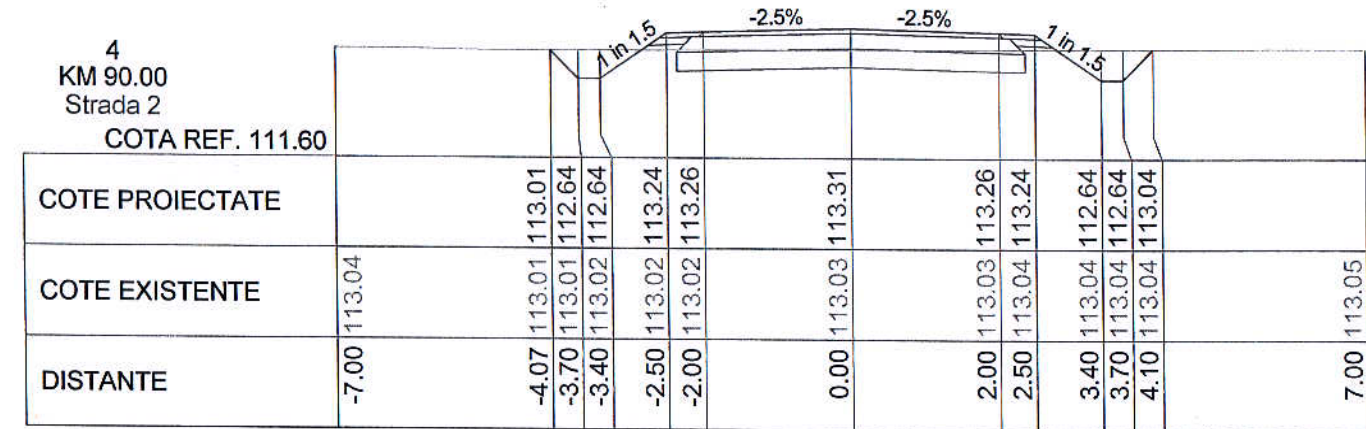
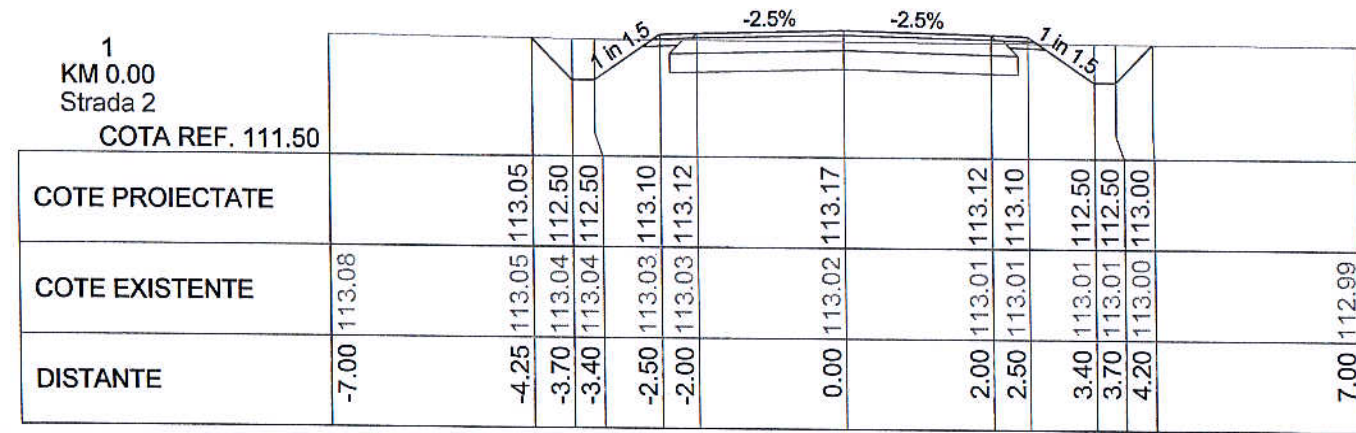
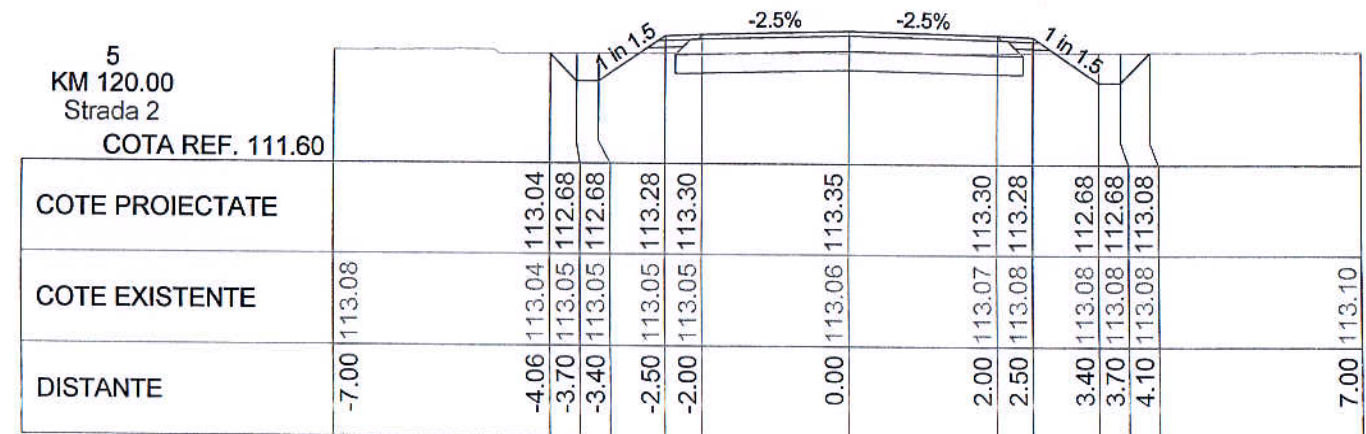
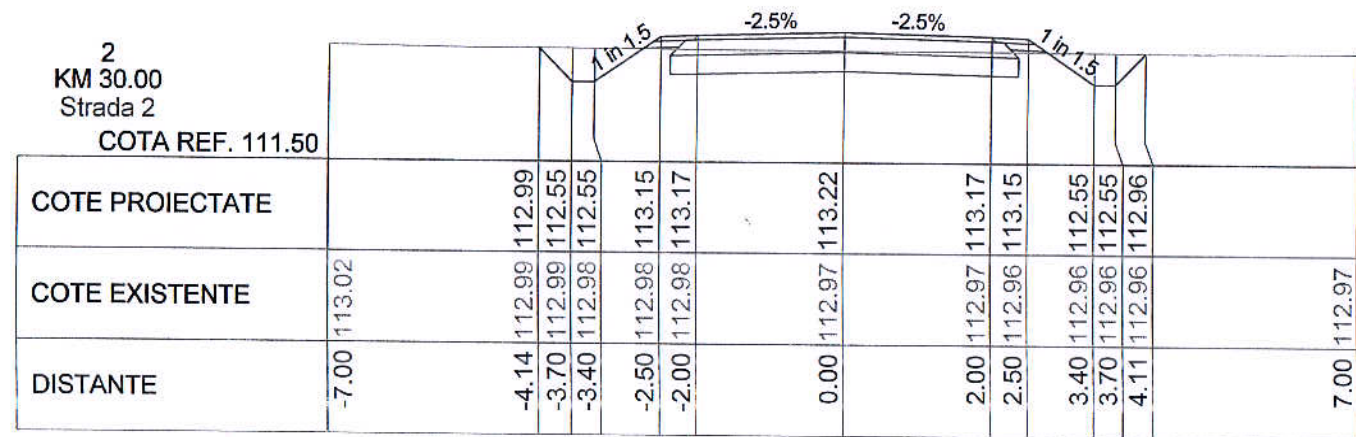
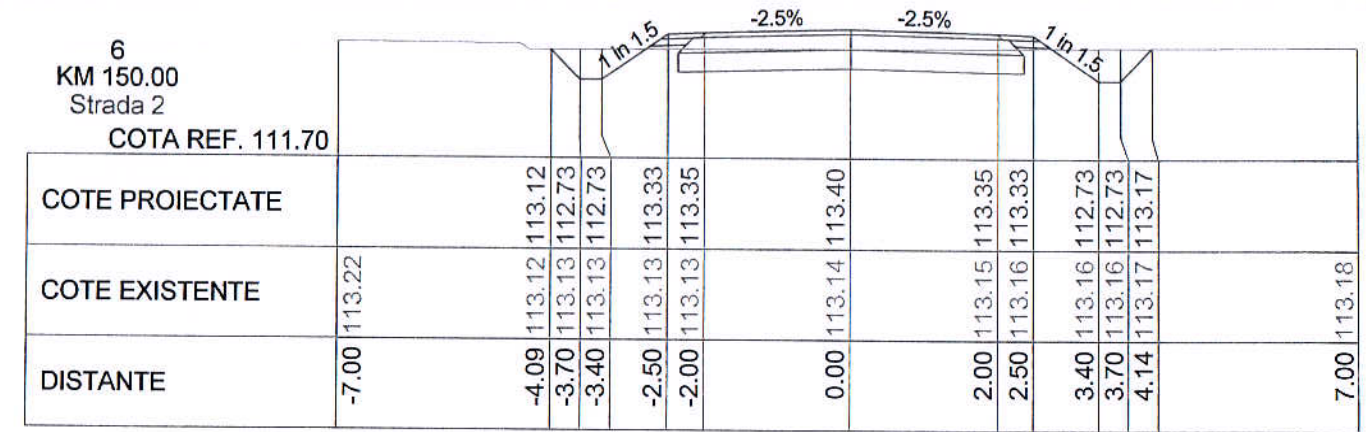
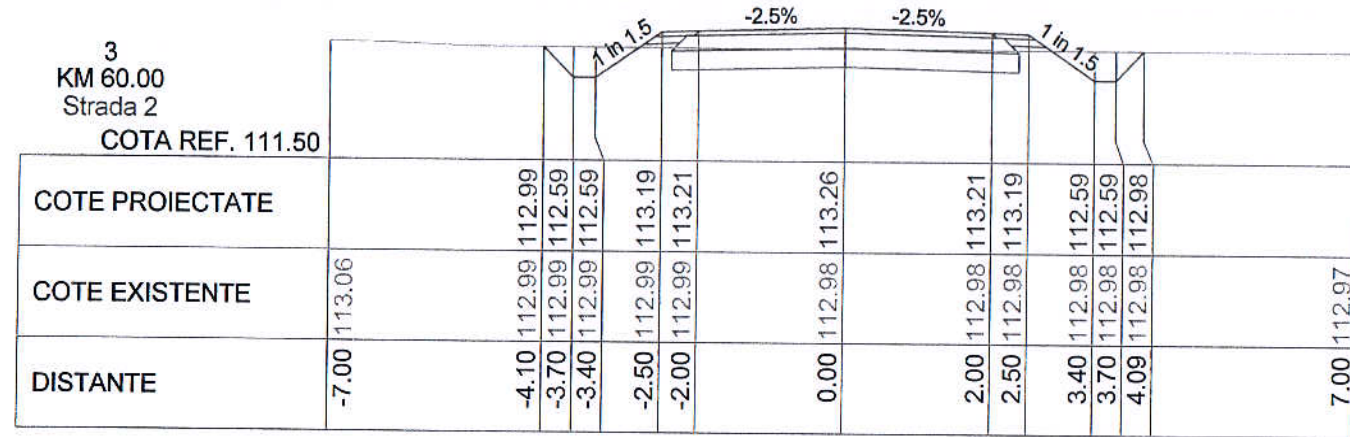

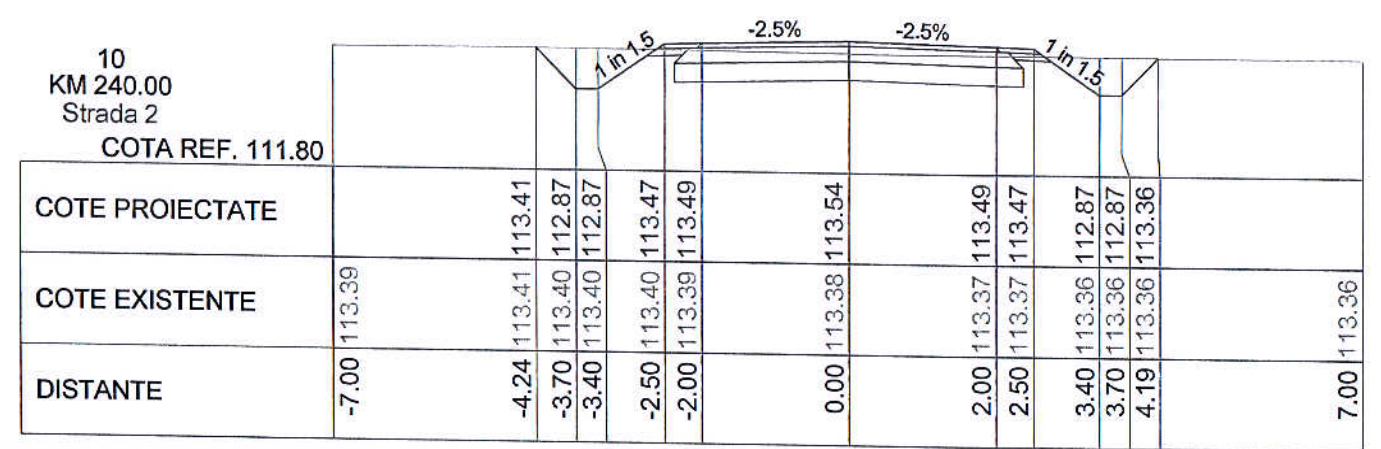
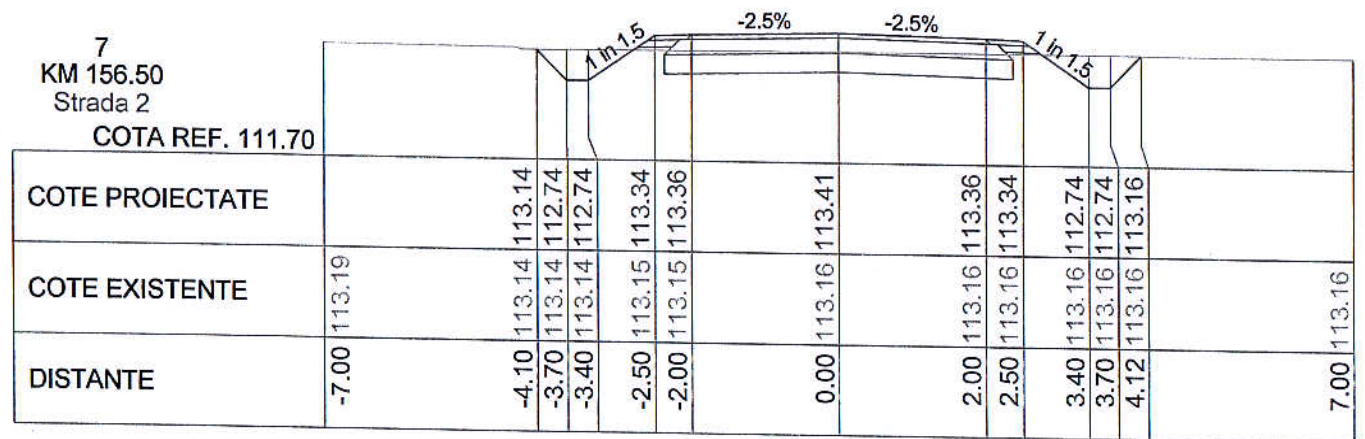
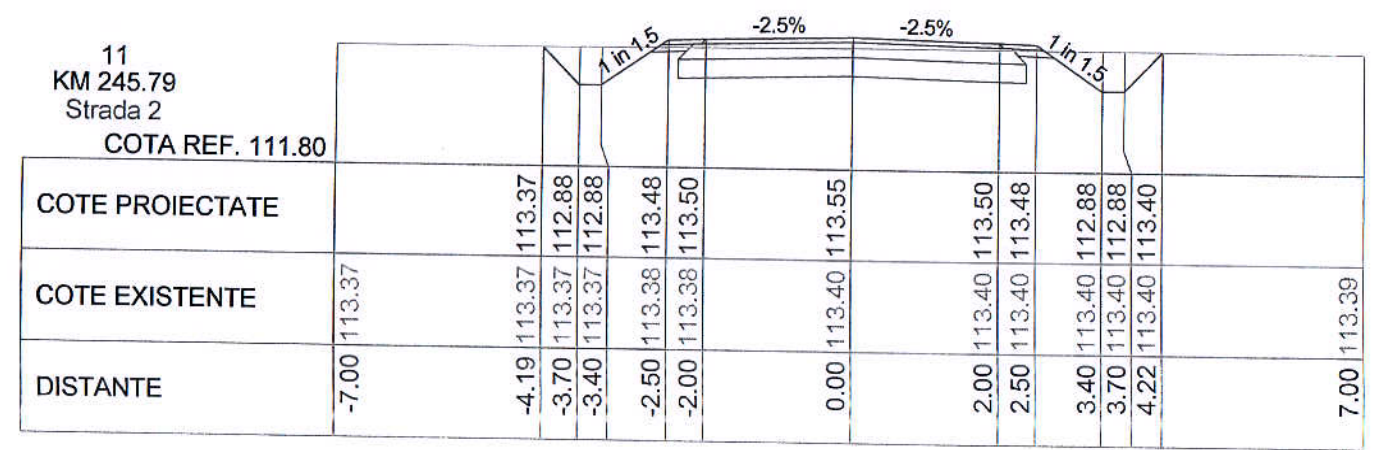
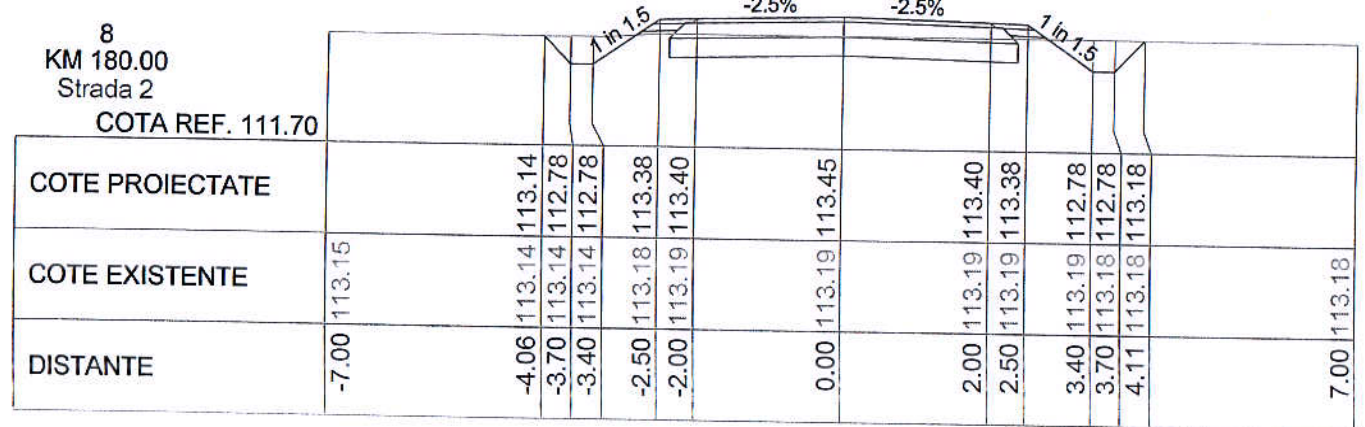
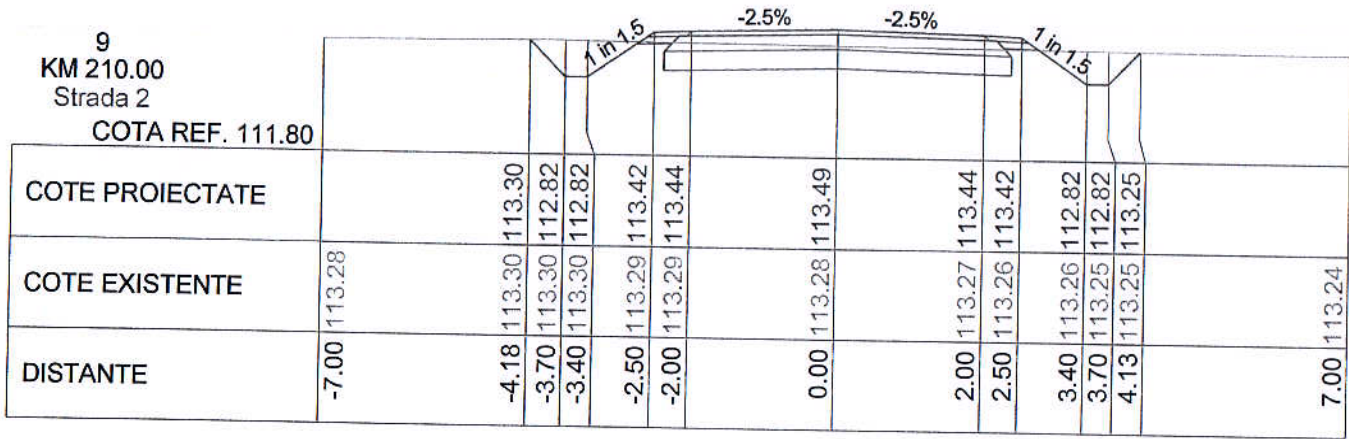

<p>SEBIS, str. Codrului nr. 1 C.U.I. 15624428 J02/912/2003 tel : +40(0)743 119 667, tel / fax: +40(0)357 437 554 e-mail : office@dromcons.ro</p>	S.C. "DROMCONS" S.R.L.		BENEFICIAR:	COMUNA VLADIMIRESCU	PROIECT NR.
			DENUMIRE PROIECT:	Amenajare străzi zonă locuințe, Vladimirescu zonă nouă, județul Arad	62/2013
			OBIECT:	DRUMURI	
SEF PROIECT:	dpl. ing. ADRIAN PRAHOVEANU	SCARA:			
PROIECTAT	Dpl. Ing. FLORE CRISTIAN	1:1000 1:100	D.T.+C.S.		
DESENAT:	Dpl. Ing. FLORE CRISTIAN	2013	PLANSA NR. 03D-04		
			PROFILURI TRANSVERSALE CURENTE Strada 2		

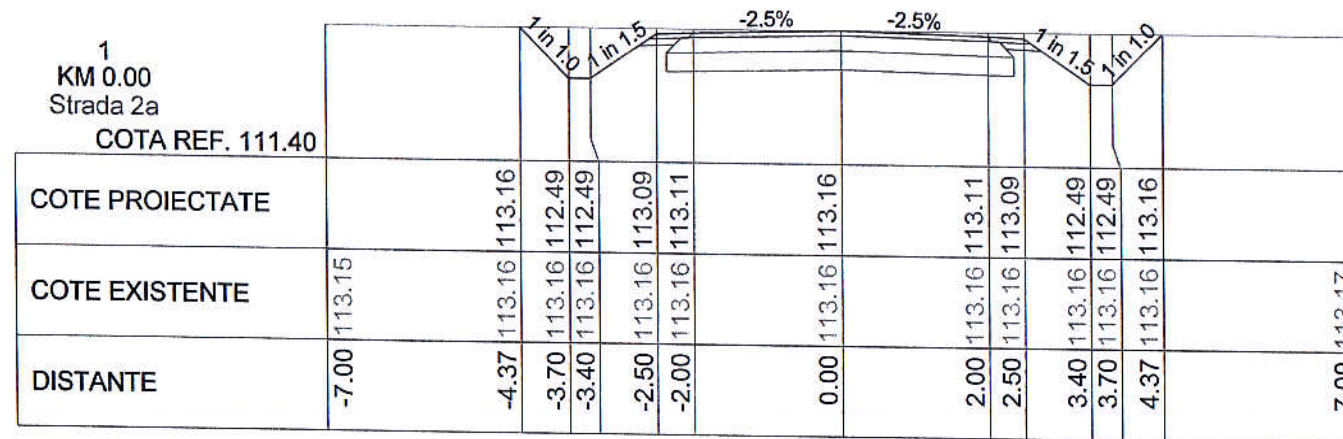
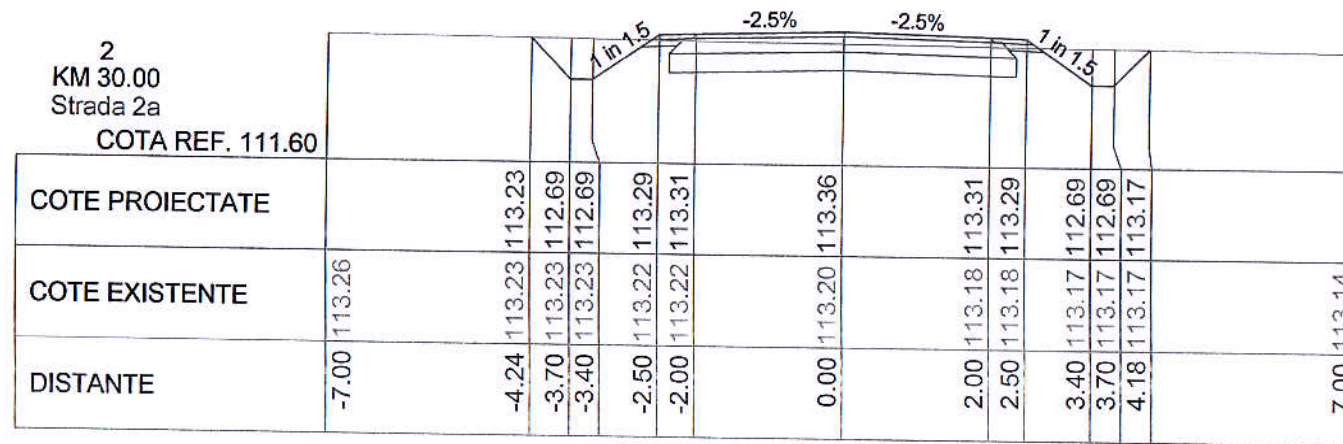
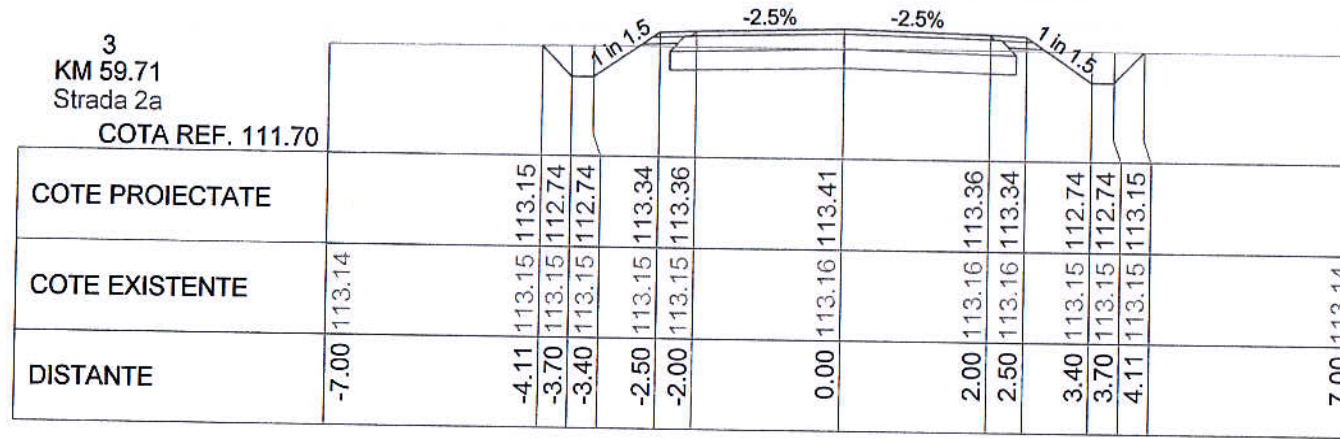

 S.C. "DROMCONS" S.R.L. SEBIS, str. Codrului nr. 1 C.U.I 15624428 J02/9/12/2003 tel : +40(0)743 119 667, tel / fax: +40(0)357 437 554 e-mail : office@dromcons.ro	BENEFICIAR:	COMUNA VLADIMIRESCU	PROIECT NR.
	DENUMIRE PROIECT:	Amenajare străzi zonă locuințe, Vladimirescu zonă nouă, județul Arad	62/2013
SEF PROIECT:	dpl. ing. ADRIAN PRAHOVEANU	OBIECT:	DRUMURI
PROIECTAT	Dpl. Ing. FLORE CRISTIAN	SCARA:	1:1000 1:100
DESEANAT:	Dpl. Ing. FLORE CRISTIAN		2013
		PROFILURI TRANSVERSALE CURENTE Strada 2	
		D.T.+C.S. PLANSA NR. 03D-05	

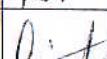
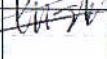

 S.C. "DROMCONS" S.R.L. SEBIS, str. Codrului nr. 1 C.U.I 15624428 J02/912/2003 tel : +40(0)743 119 667, tel / fax: +40(0)357 437 554 e-mail : office@dromcons.ro		BENEFICIAR:	COMUNA VLADIMIRESCU	PROIECT NR.	
	DENUMIRE PROIECT:	Amenajare străzi zonă locuințe, Vladimirescu zonă nouă, județul Arad	62/2013		
	OBIECT:	DRUMURI	D.T.+C.S.		
SEF PROIECT:	dpl. ing. ADRIAN PRAHOVEANU 	SCARA:	1:1000 1:100	PROFILURI TRANSVERSALE CURENTE Strada 2a	PLANSA NR. 03D-06
PROIECTAT	Dpl. Ing. FLORE CRISTIAN 	2013			
DESENAT:	Dpl. Ing. FLORE CRISTIAN 				

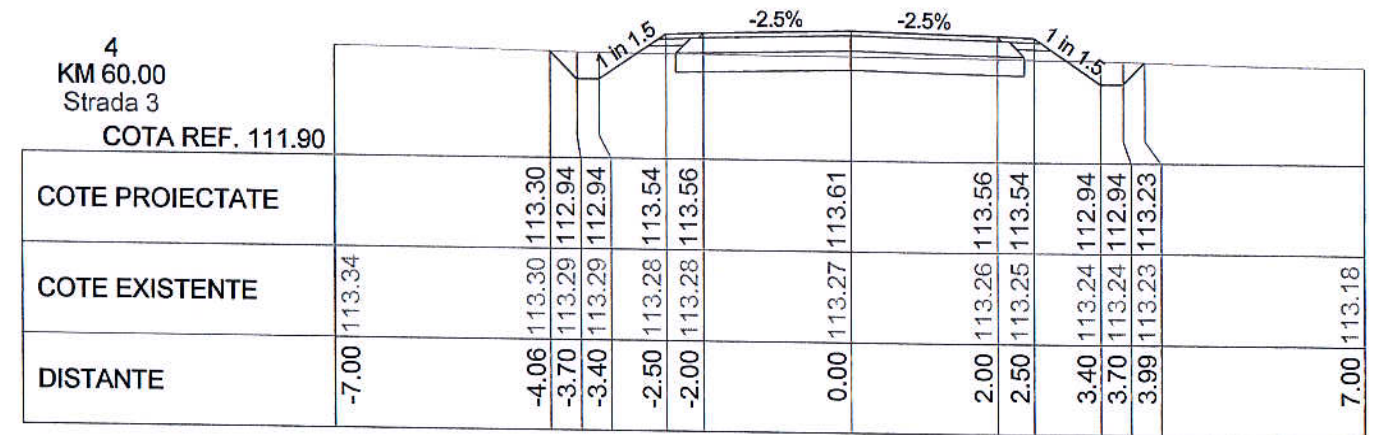
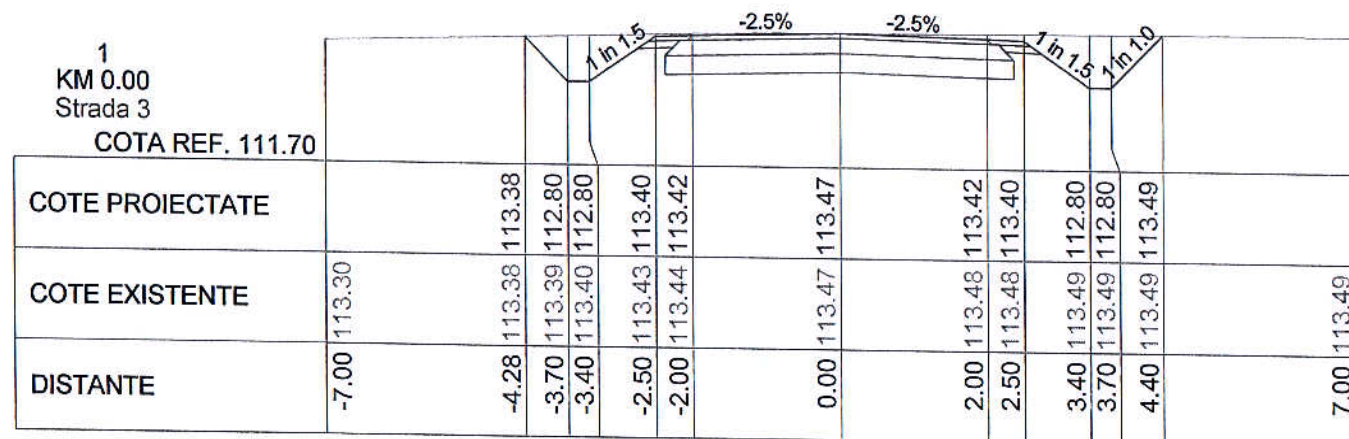
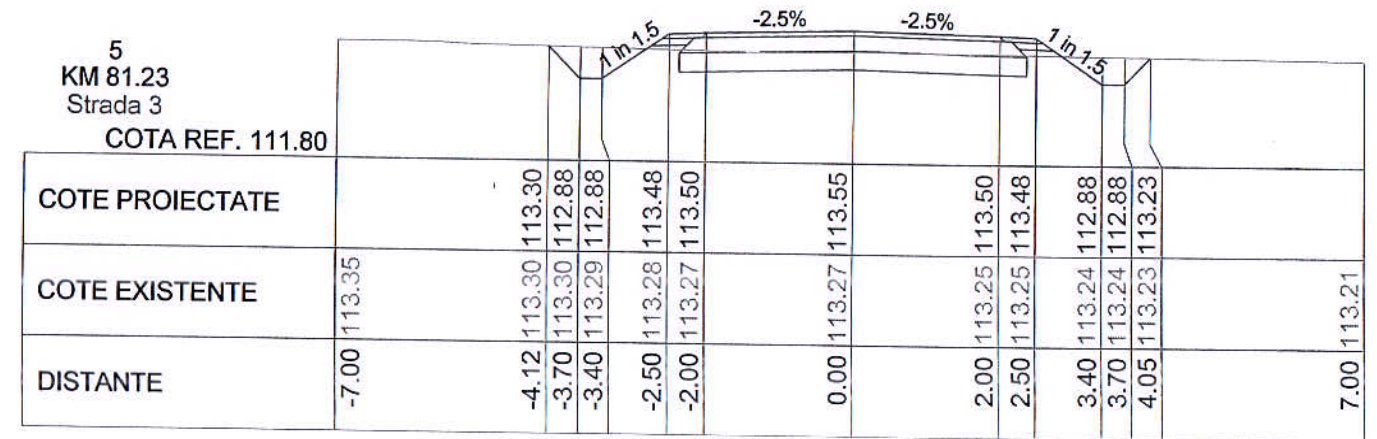
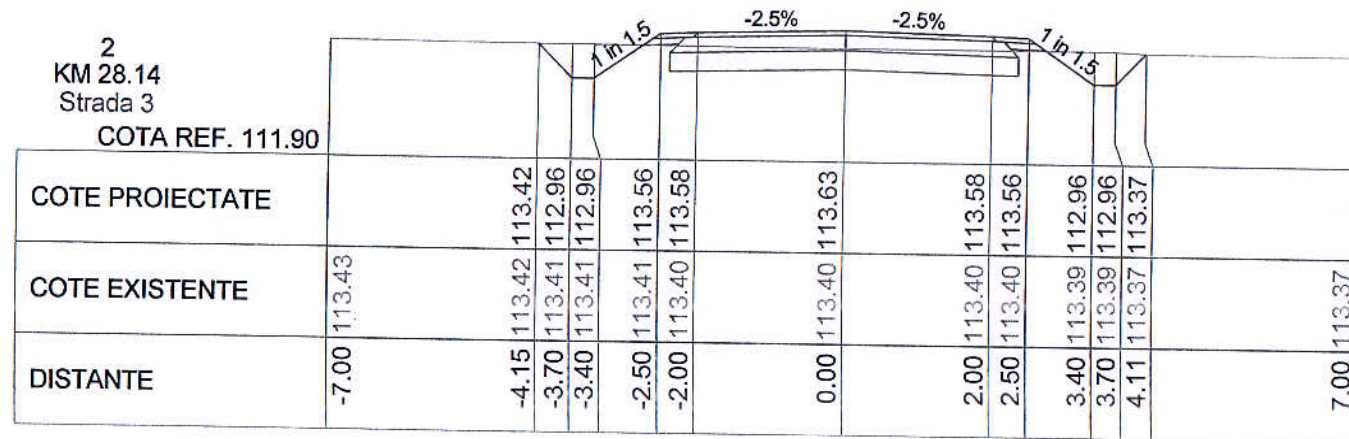
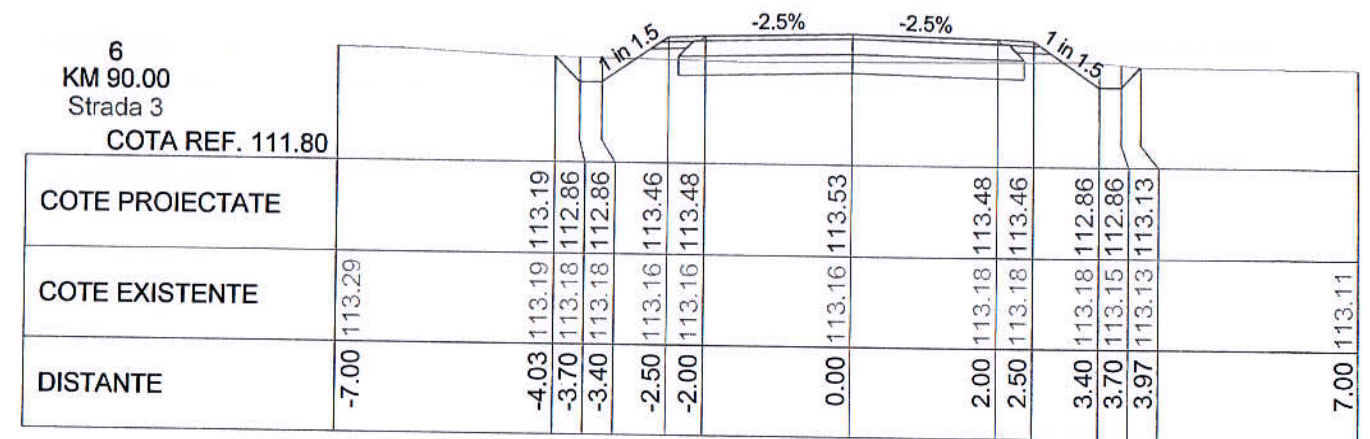
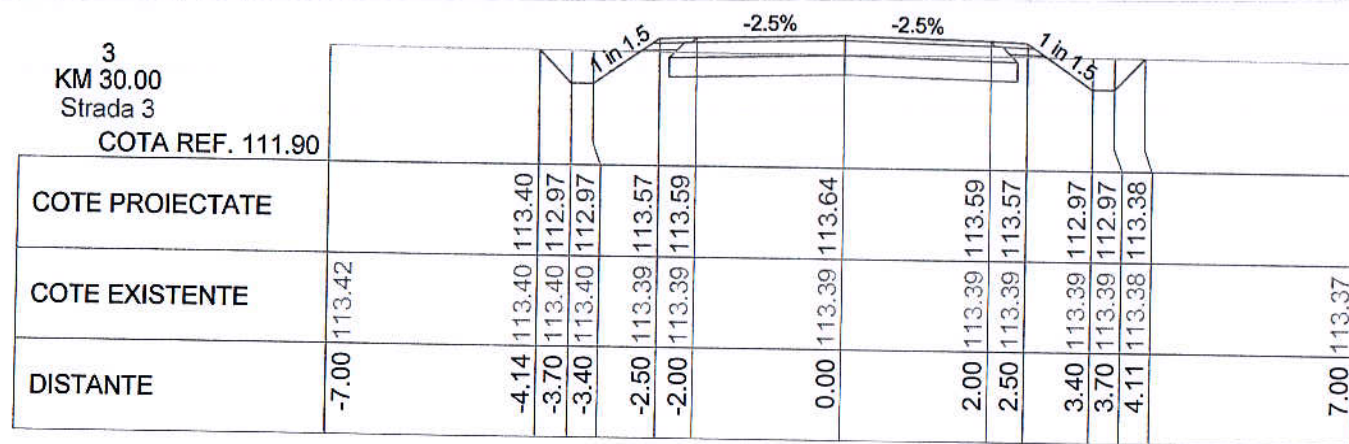

 S.C. "DROMCONS" S.R.L. SEBIS, str. Codrului nr. 1 C.U.I 15624428 J02/9/12/2003 tel : +40(0)743 119 667, tel / fax: +40(0)357 437 554 e-mail : office@dromcons.ro	BENEFICIAR:	COMUNA VLADIMIRESCU	PROIECT NR.
	DENUMIRE PROIECT:	Amenajare străzi zonă locuințe, Vladimirescu zonă nouă, județul Arad	62/2013
SEF PROIECT:	dpl. ing. ADRIAN PRAHOVEANU	OBIECT:	DRUMURI
PROIECTAT	Dpl. Ing. FLORE CRISTIAN	SCARA:	1:1000 1:100
DESEANAT:	Dpl. Ing. FLORE CRISTIAN	2013	PROFILURI TRANSVERSALE CURENTE Strada 3
			D.T.+C.S. PLANSĂ NR. 03D-07

21
KM 330.00
Strada 3
COTA REF. 111.60

COTE PROIECTATE										
COTE EXISTENTE	113.15		113.14	112.67	112.67	113.27	113.29	113.34	113.29	113.12
DISTANTE	-7.00	-4.17	-3.70	-3.40	-2.50	-2.00	0.00	2.00	2.50	3.40

24
KM 390.00
Strada 3
COTA REF. 111.90

COTE PROIECTATE										
COTE EXISTENTE	113.31		113.32	112.91	112.91	113.51	113.53	113.58	113.53	113.36
DISTANTE	-7.00	-4.11	-3.70	-3.40	-2.50	-2.00	0.00	2.00	2.50	3.40

20
KM 308.95
Strada 3
COTA REF. 111.50

COTE PROIECTATE										
COTE EXISTENTE	112.92		112.91	112.52	112.52	113.12	113.14	113.19	113.12	112.89
DISTANTE	-7.00	-4.09	-3.70	-3.40	-2.50	-2.00	0.00	2.00	2.50	3.40

23
KM 368.95
Strada 3
COTA REF. 111.90

COTE PROIECTATE										
COTE EXISTENTE	113.27		113.28	112.91	112.91	113.51	113.53	113.58	113.53	113.32
DISTANTE	-7.00	-4.07	-3.70	-3.40	-2.50	-2.00	0.00	2.00	2.50	3.40

19
KM 300.00
Strada 3
COTA REF. 111.40

COTE PROIECTATE										
COTE EXISTENTE	112.90		112.87	112.49	112.49	113.09	113.11	113.16	113.09	112.82
DISTANTE	-7.00	-4.08	-3.70	-3.40	-2.50	-2.00	0.00	2.00	2.50	3.40

22
KM 360.00
Strada 3
COTA REF. 111.80

COTE PROIECTATE										
COTE EXISTENTE	113.25		113.26	112.88	112.88	113.48	113.50	113.55	113.50	113.28
DISTANTE	-7.00	-4.08	-3.70	-3.40	-2.50	-2.00	0.00	2.00	2.50	3.40



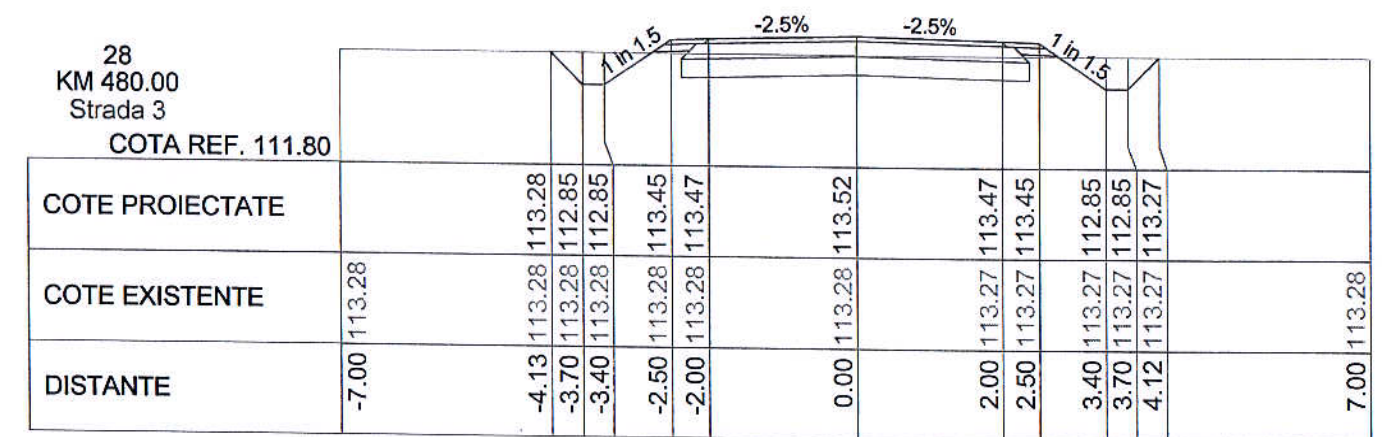
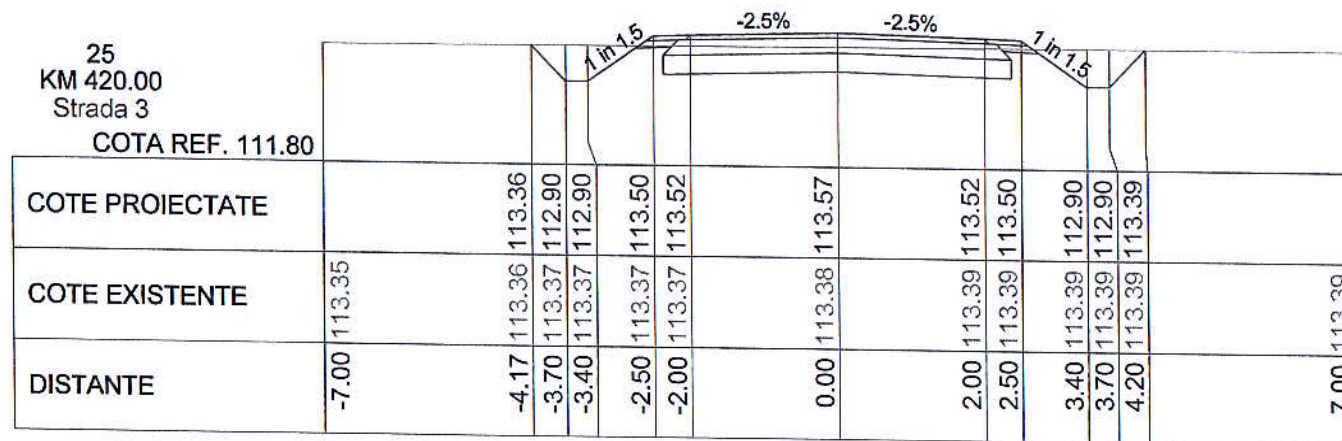
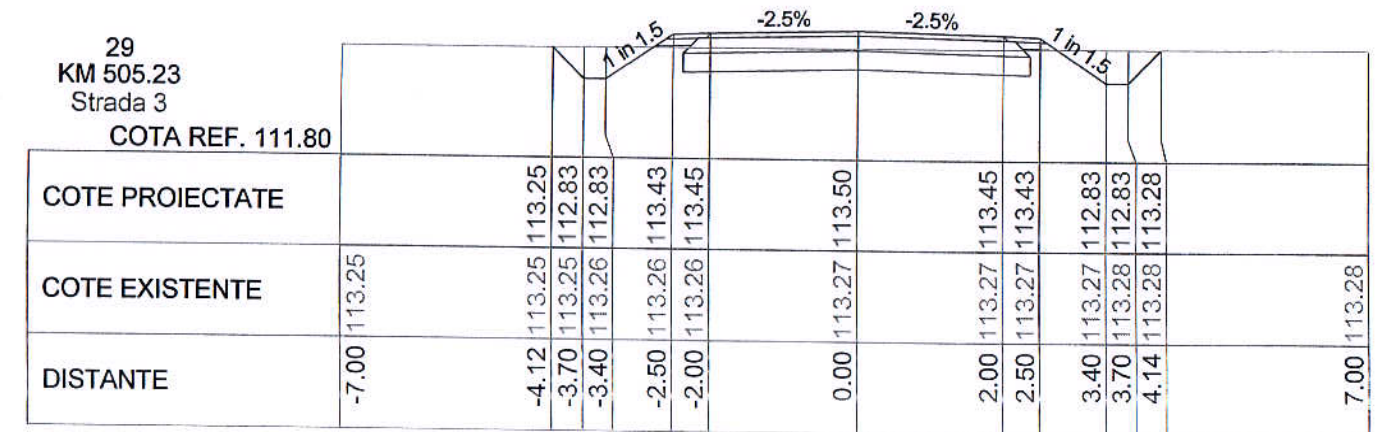
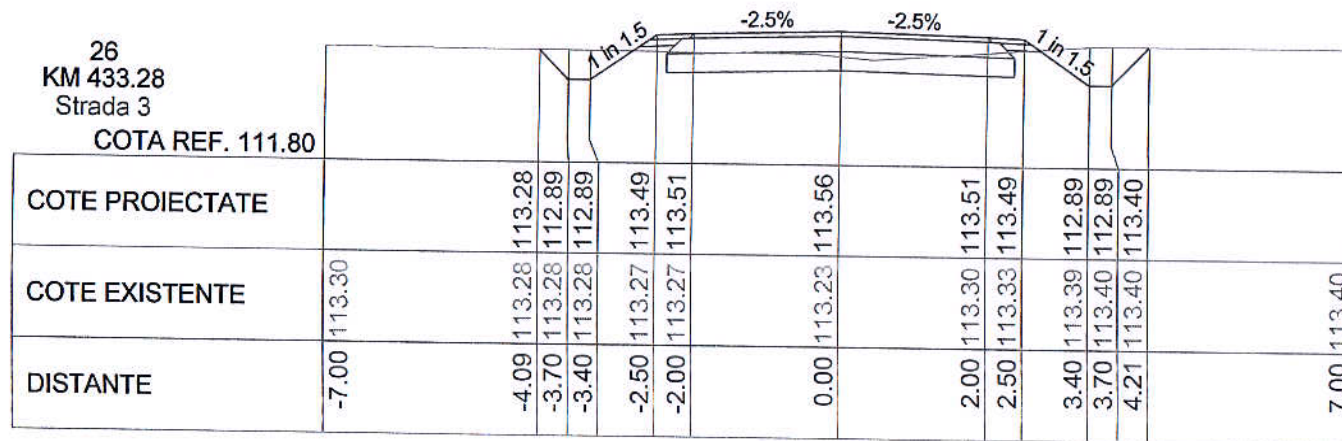
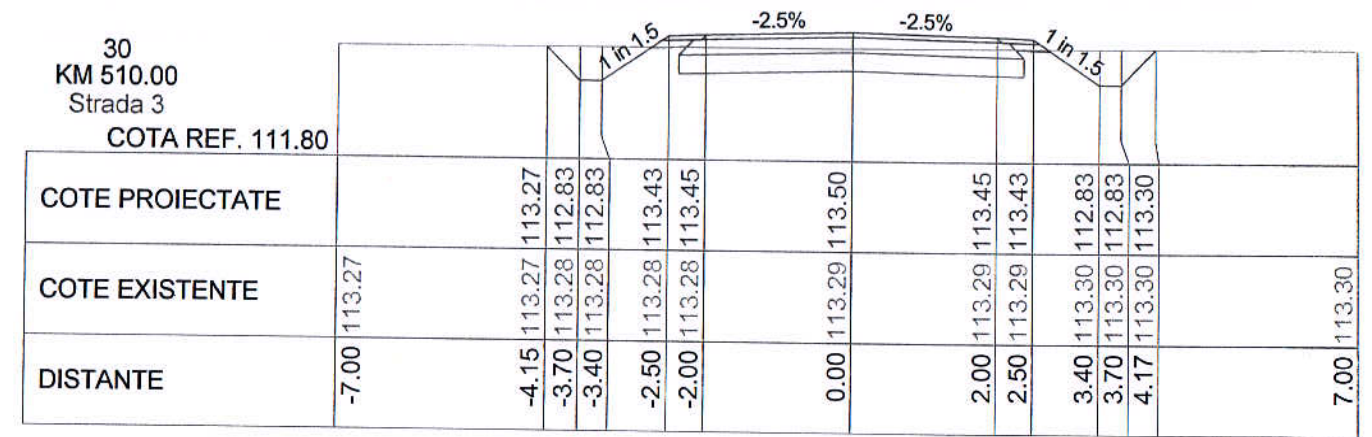
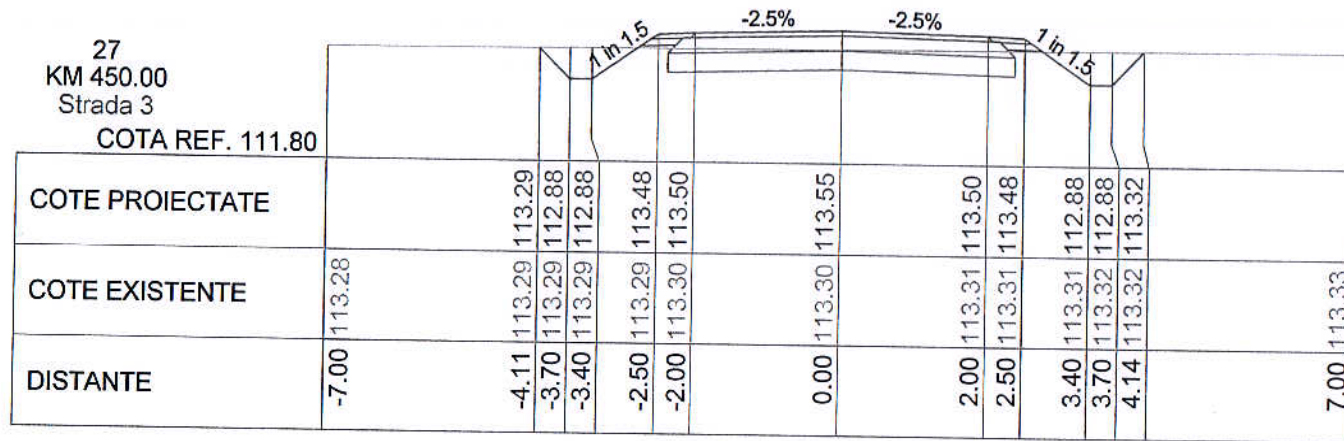

 S.C. "DROMCONS" S.R.L. SEBIS, str. Codrului nr. 1 C.U.I 15624428 JO2/912/2003 tel : +40(0)743 119 667, tel / fax: +40(0)357 437 554 e-mail : office@dromcons.ro	BENEFICIAR:	COMUNA VLADIMIRESCU	PROIECT NR.
	DENUMIRE PROIECT:	Amenajare străzi zonă locuințe, Vladimirescu zonă nouă, județul Arad	62/2013
	OBIECT:	DRUMURI	D.T.+C.S.
SEF PROIECT:	dpl. ing. ADRIAN PRAHOVEANU	SCARA:	1:1000 1:100
PROIECTAT	Dpl. Ing. FLORE CRISTIAN	PROFILURI TRANSVERSALE CURENTE Strada 3	
DESENAT:	Dpl. Ing. FLORE CRISTIAN	2013	PLANSĂ NR. 03D-10

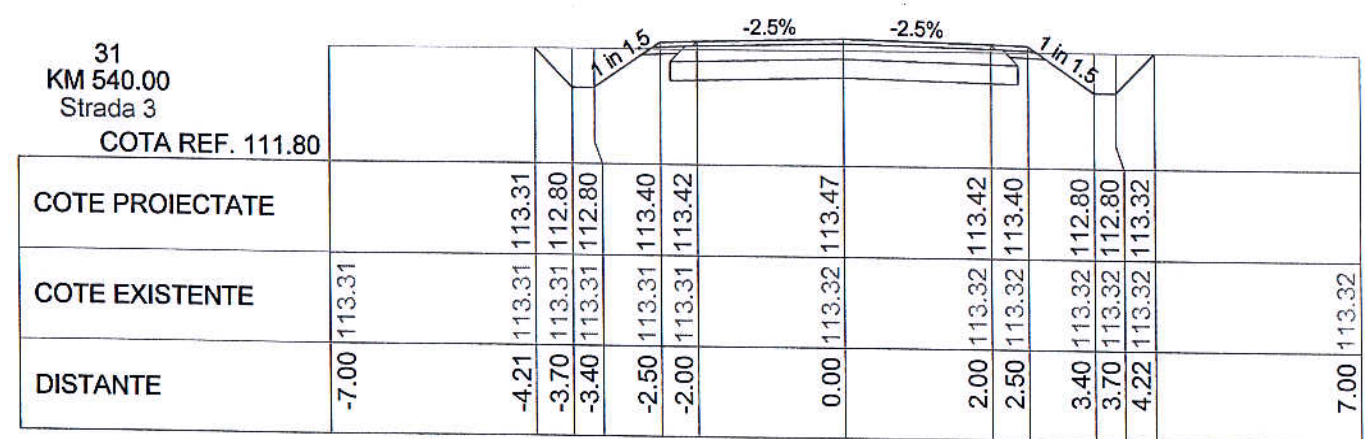
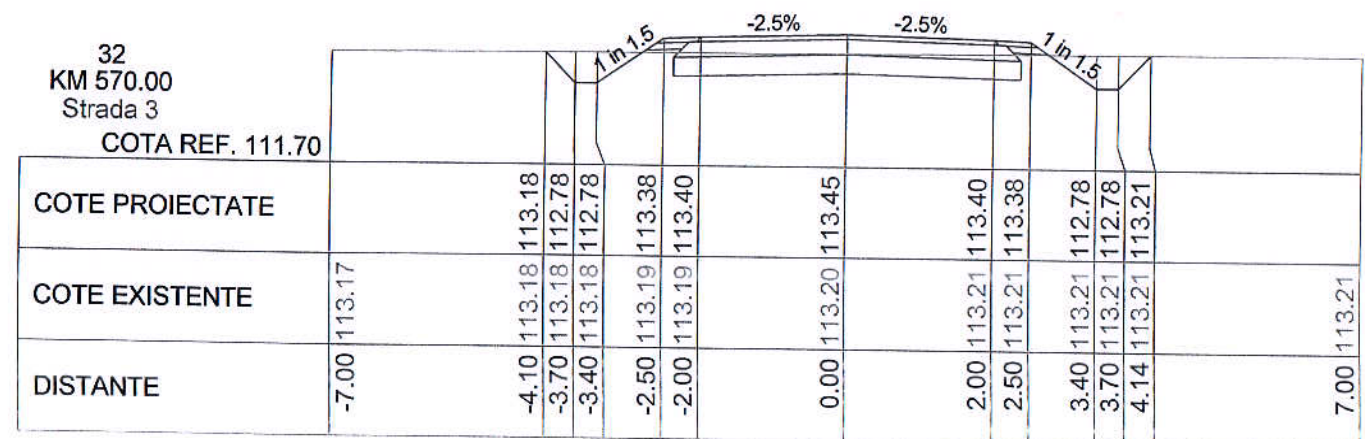
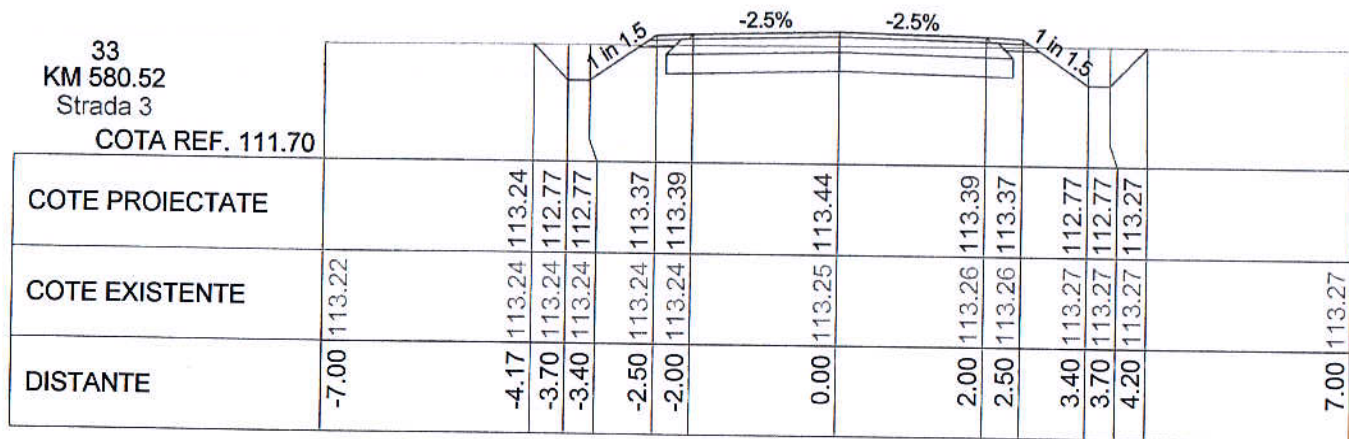

<p>S.C. "DROMCONS" S.R.L. SEBIS, str. Codrului nr. 1 C.U.I 15624428 J02/912/2003 tel : +40(0)743 119 667, tel / fax: +40(0)357 437 554 e-mail : office@dromcons.ro</p>	BENEFICIAR:	COMUNA VLADIMIRESCU	PROIECT NR.
	DENUMIRE PROIECT:	Amenajare străzi zonă locuințe, Vladimirescu zonă nouă, județul Arad	62/2013
SEF PROIECT:	dpl. Ing. ADRIAN PRAHOVEANU	OBIECT:	DRUMURI
PROIECTAT	Dpl. Ing. FLORE CRISTIAN	SCARA:	1:1000 1:100
DESEANAT:	Dpl. Ing. FLORE CRISTIAN	2013	PROFILURI TRANSVERSALE CURENTE Strada 3
			D.T.+C.S. PLANSĂ NR. 03D-11



 S.C. "DROMCONS" S.R.L. SEBIS, str. Codrului nr. 1 C.U.I 15624428 J02/912/2003 tel: +40(0)743 119 667, tel / fax: +40(0)357 437 554 e-mail: office@dromcons.ro		BENEFICIAR:	COMUNA VLADIMIRESCU	PROIECT NR.	
		DENUMIRE PROIECT:	Amenajare străzi zonă locuințe, Vladimirescu zonă nouă, județul Arad		62/2013
		OBIECT:	DRUMURI		
SEF PROIECT:	dpl. ing. ADRIAN PRAHOVEANU	SCARA:			D.T.+C.S.
PROIECTAT	Dpl. Ing. FLORE CRISTIAN	1:1000 1:100	PROFILURI TRANSVERSALE CURENTE Strada 3		
DESEMAT:	Dpl. Ing. FLORE CRISTIAN	2013			PLANSĂ NR. 03D-12

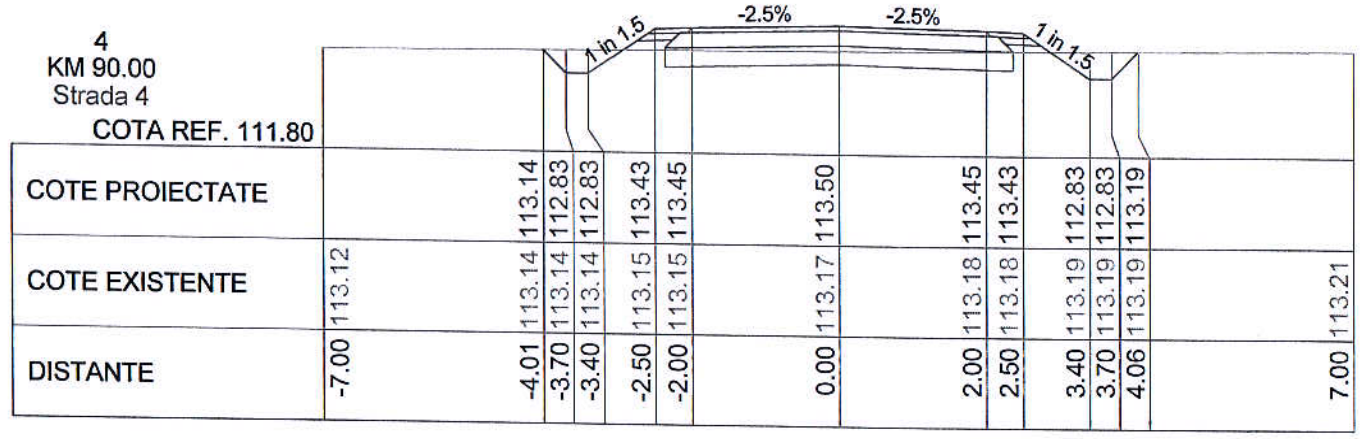
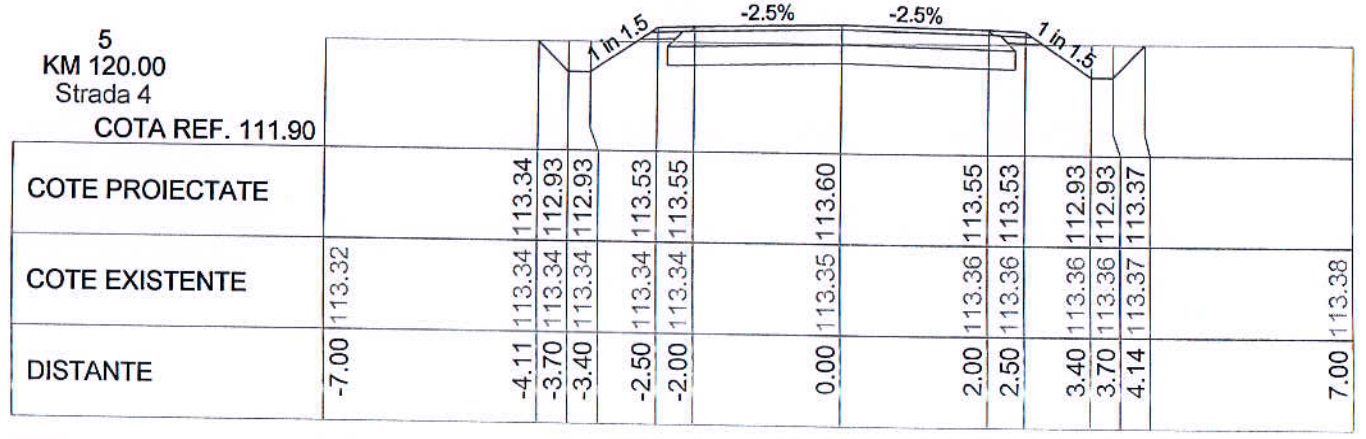
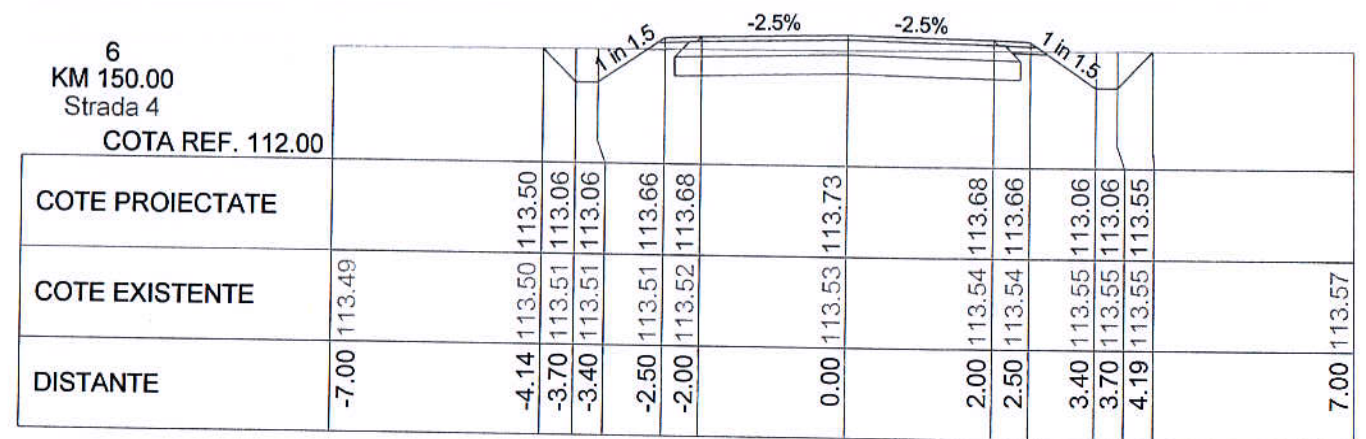
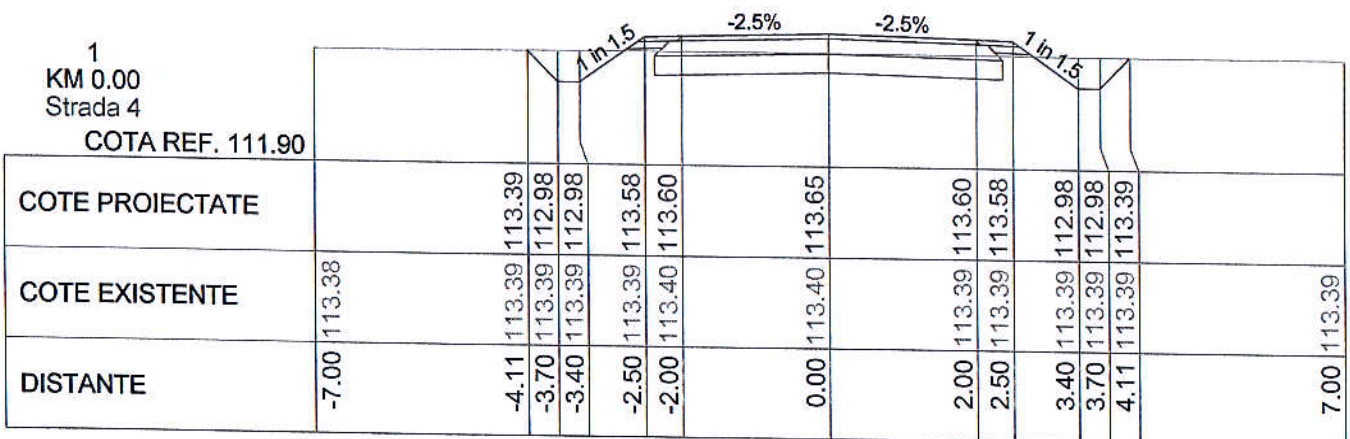
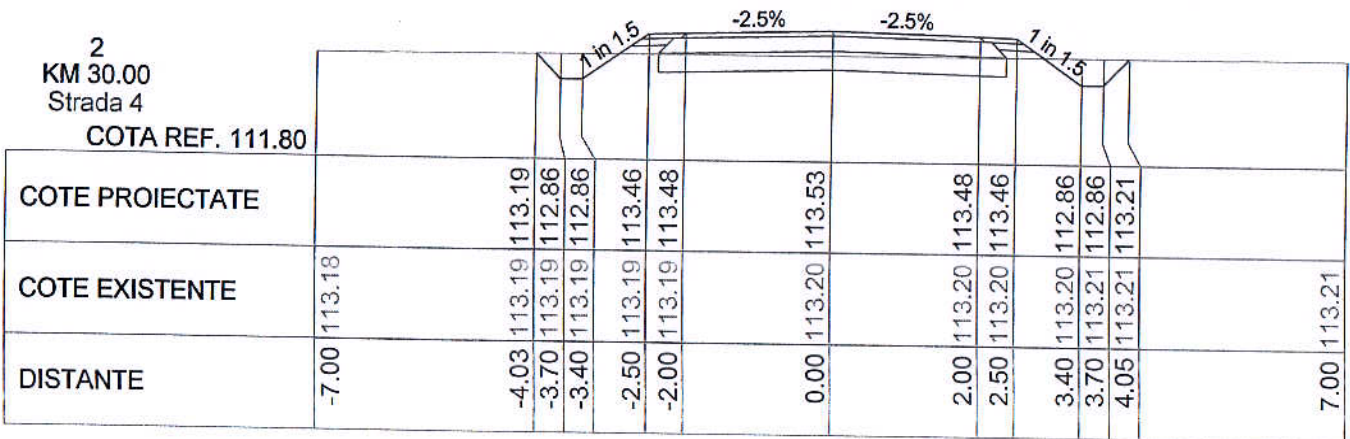
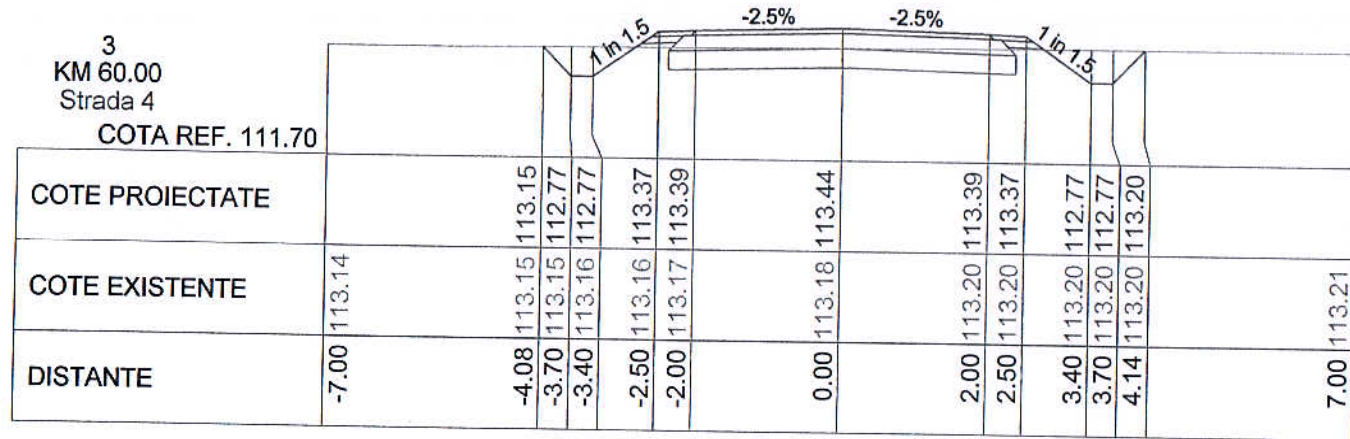

 S.C. "DROMCONS" S.R.L. SEBIS, str. Codrului nr. 1 C.U.I 15624428 J02/9/12/2003 tel : +40(0)743 119 667 tel / fax : +40(0)357 437 554 e-mail : office@dromcons.ro	BENEFICIAR:	COMUNA VLADIMIRESCU	PROIECT NR.
	DENUMIRE PROIECT:	Amenajare străzi zonă locuințe, Vladimirescu zonă nouă, județul Arad	62/2013
	OBIECT:	DRUMURI	D.T.+C.S.
	SEF PROIECT:	dpl. Ing. ADRIAN PRAHOVEANU	SCARA:
PROIECTAT	Dpl. Ing. FLORE CRISTIAN	PROFILURI TRANSVERSALE CURENTE Strada 4	
DESENAT:	Dpl. Ing. FLORE CRISTIAN	PLANSĂ NR. 03D-13	

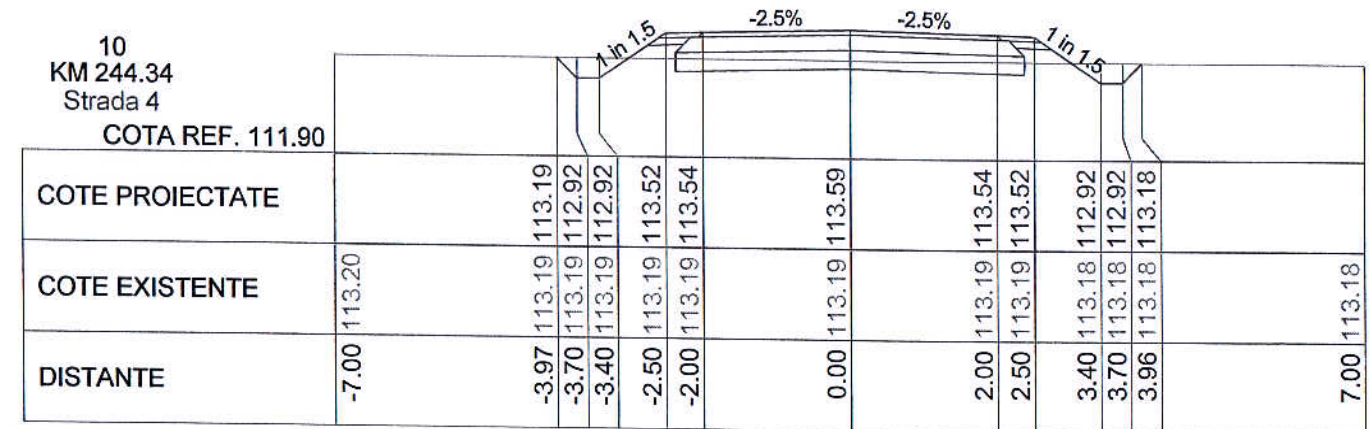
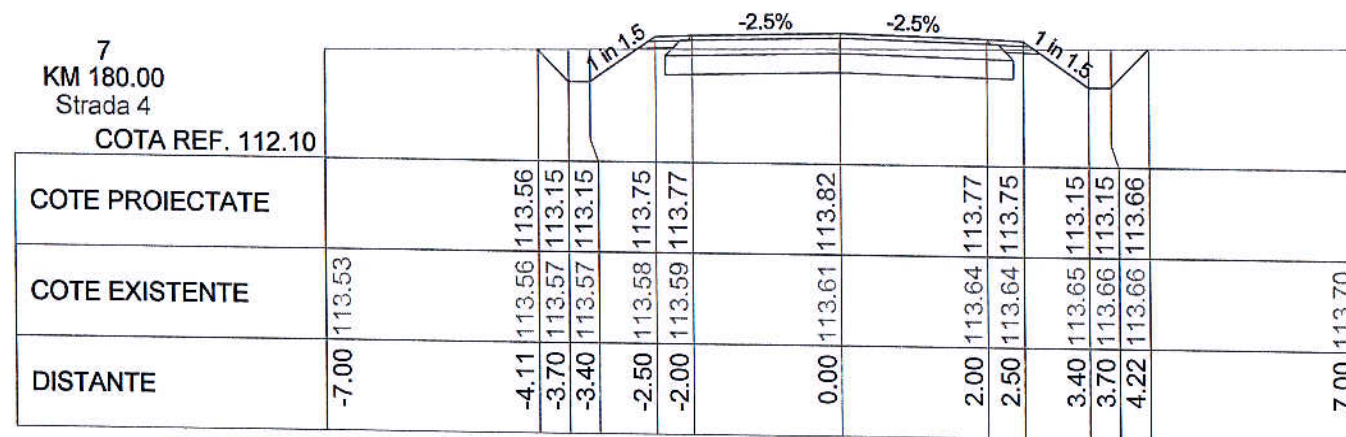
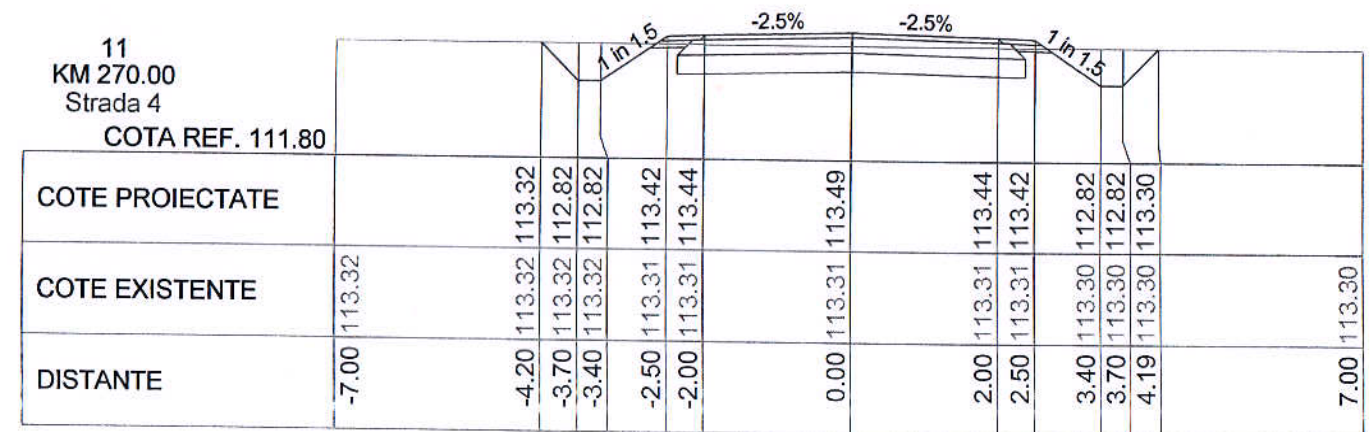
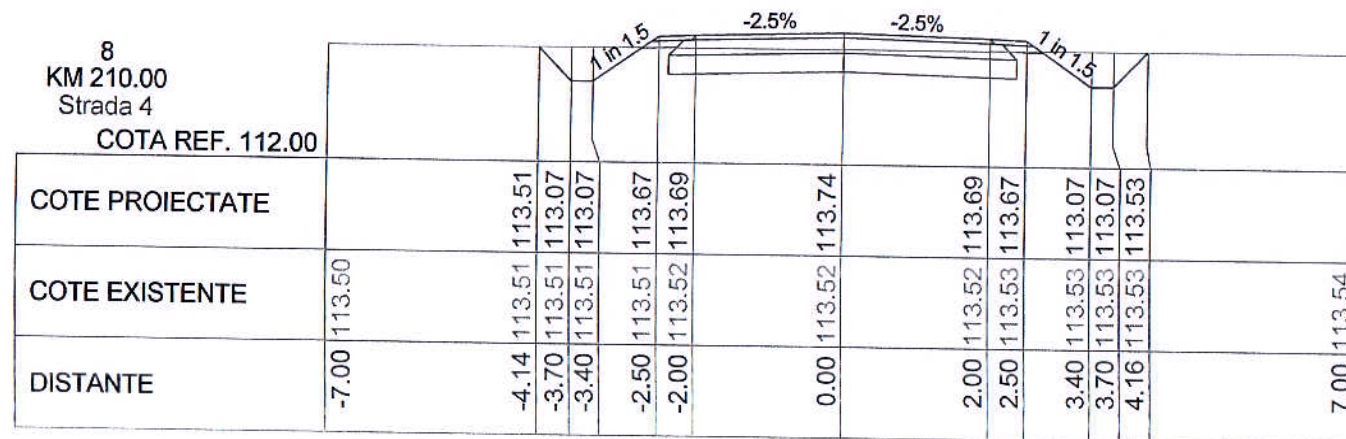
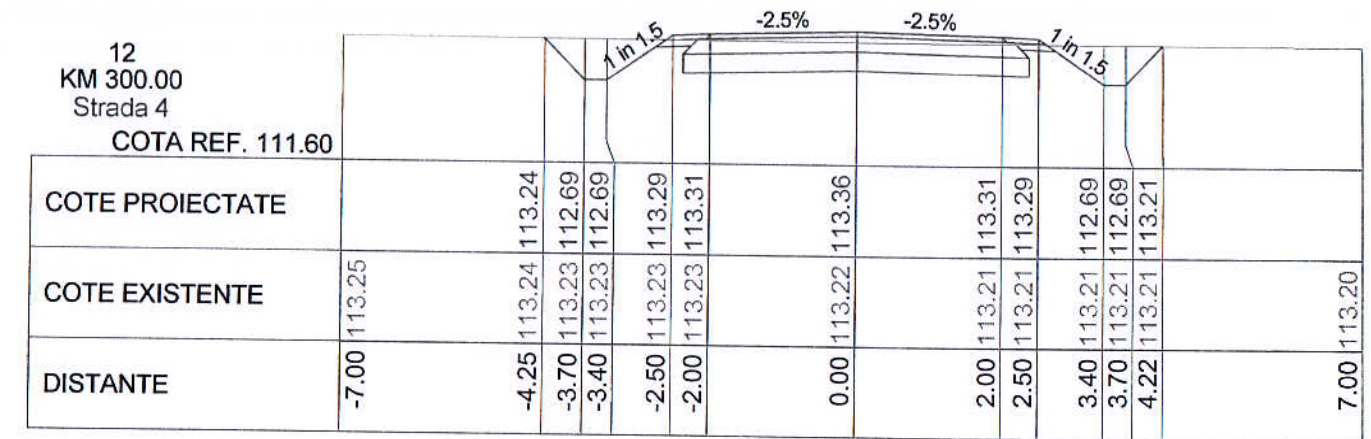
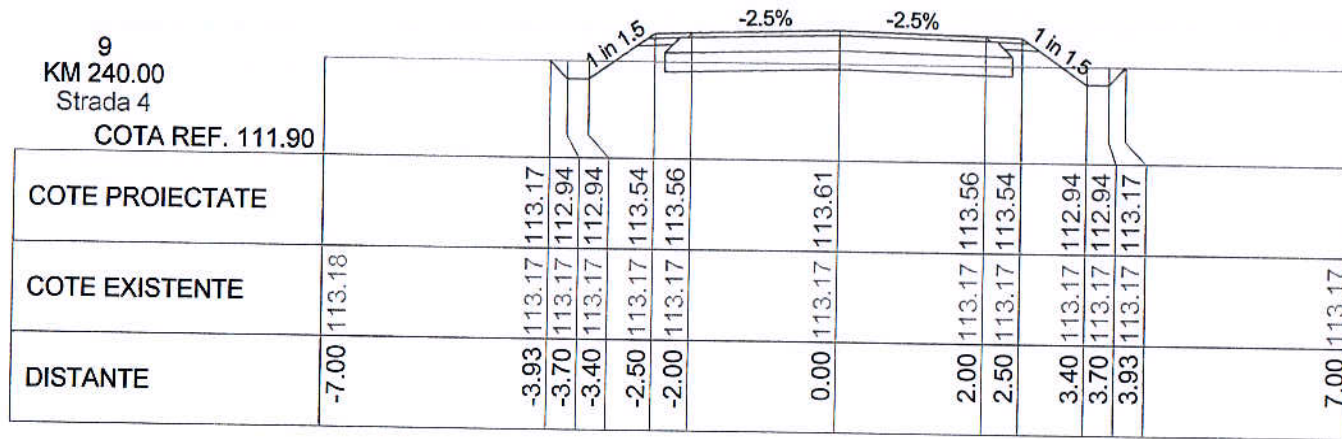

 S.C. "DROMCONS" S.R.L. SEBIS, str. Codrulului nr. 1 C.U.I 15624428 J02/912/2003 tel : +40(0)743 119 667 tel / fax: +40(0)357 437 554 e-mail : office@dromcons.ro	BENEFICIAR:	COMUNA VLADIMIRESCU	PROIECT NR.
	DENUMIRE PROIECT:	Amenajare străzi zonă locuințe, Vladimirescu zonă nouă, județul Arad	62/2013
SEF PROIECT:	dpl. ing. ADRIAN PRAHOVEANU	OBIECT:	DRUMURI
PROIECTAT	Dpl. ing. FLORE CRISTIAN	SCARA:	1:1000 1:100
DESENAT:	Dpl. ing. FLORE CRISTIAN	2013	PROFILURI TRANSVERSALE CURENTE Strada 4
			D.T.+C.S. PLANSĂ NR. 03D-14

15
KM 360.00
Strada 4

COTA REF. 111.40

COTE PROIECTATE																				
COTE EXISTENTE	112.85		112.83	112.83	112.44	112.44	113.04	113.06		113.11			113.06	113.04	112.78	112.44	112.44	112.78	112.78	112.76
DISTANTE	-7.00		-4.09	-3.70	-3.40	-2.50	-2.00	0.00		2.00	2.50	3.40	3.70	4.04						7.00

14
KM 330.00
Strada 4

COTA REF. 111.50

COTE PROIECTATE																				
COTE EXISTENTE	113.12		113.10	112.57	112.57	113.17	113.19		113.24			113.19	113.17	112.57	112.57	113.04				113.02
DISTANTE	-7.00		-4.24	-3.70	-3.40	-2.50	-2.00	0.00		2.00	2.50	3.40	3.70	4.18						7.00

13
KM 316.29
Strada 4

COTA REF. 111.60

COTE PROIECTATE																				
COTE EXISTENTE	113.08		113.01	112.62	112.62	113.22	113.24		113.29			113.24	113.22	112.62	112.62	113.07				113.08
DISTANTE	-7.00		-4.08	-3.70	-3.40	-2.50	-2.00	0.00		2.00	2.50	3.40	3.70	4.15						7.00

16
KM 382.48
Strada 4

COTA REF. 111.30

COTE PROIECTATE																				
COTE EXISTENTE	112.80		112.77	112.35	112.35	112.95	112.97		113.02			112.97	112.95	112.35	112.35	112.68				112.64
DISTANTE	-7.00		-4.12	-3.70	-3.40	-2.50	-2.00	0.00		2.00	2.50	3.40	3.70	4.03						7.00



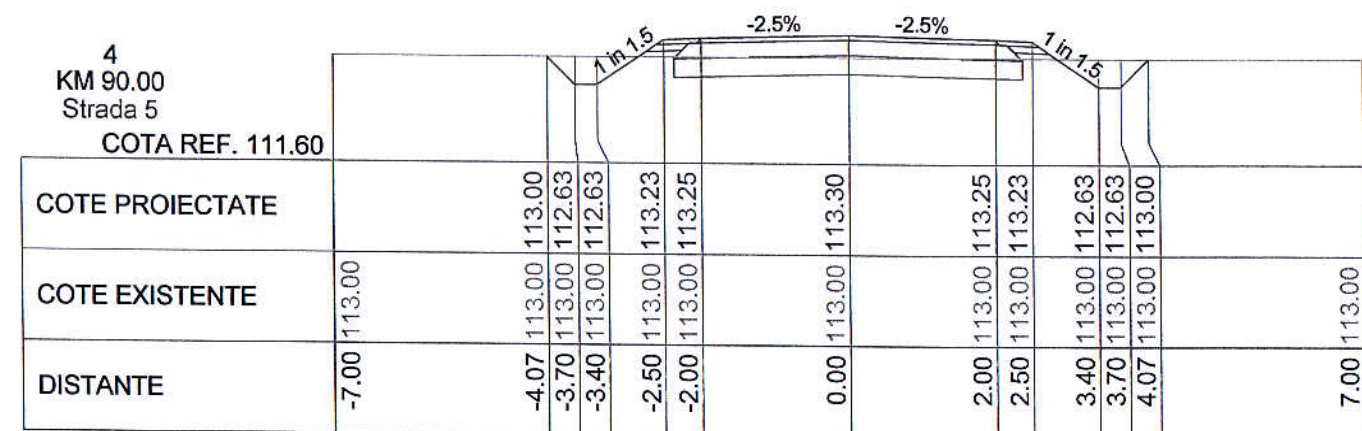
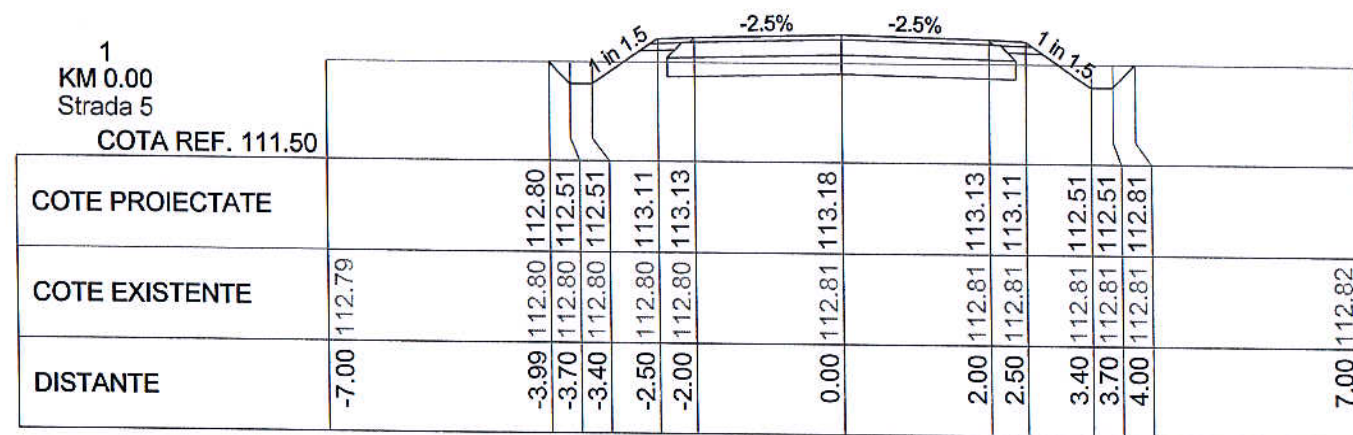
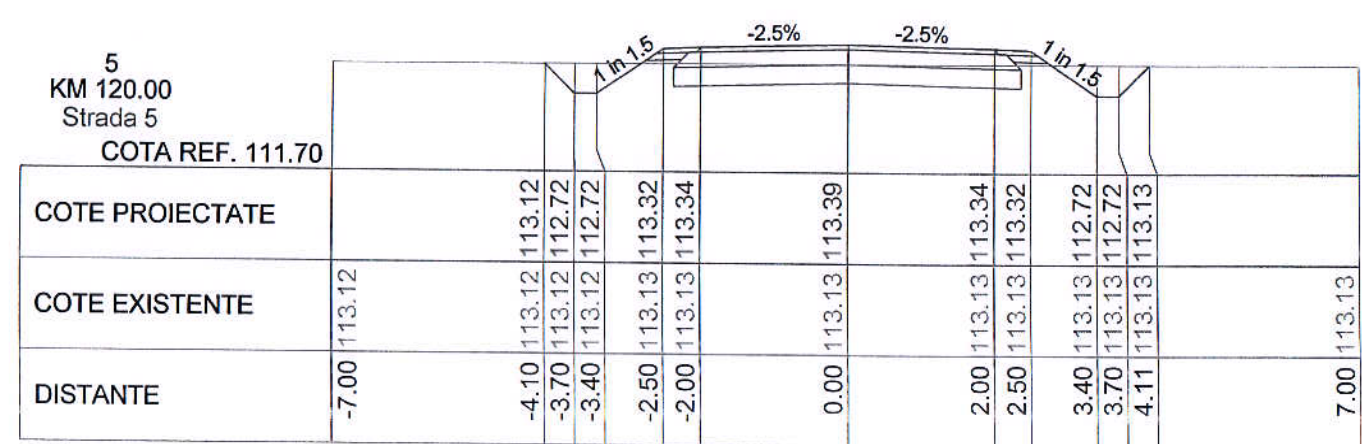
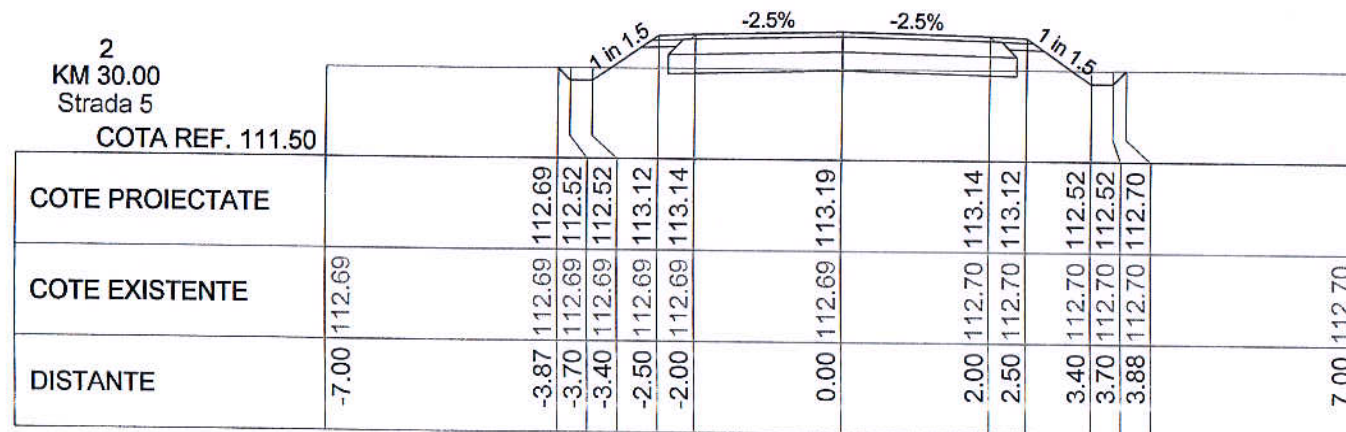
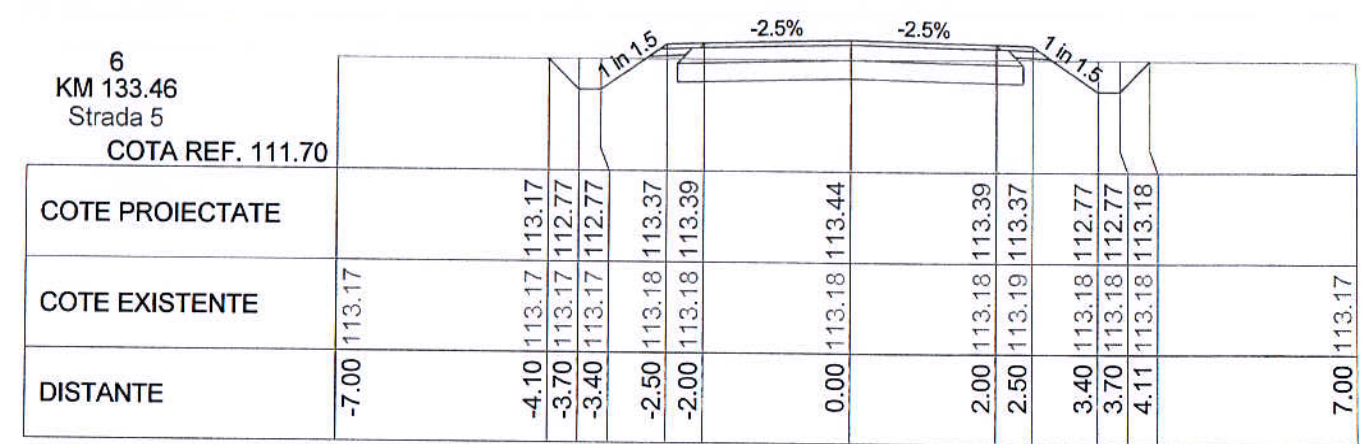
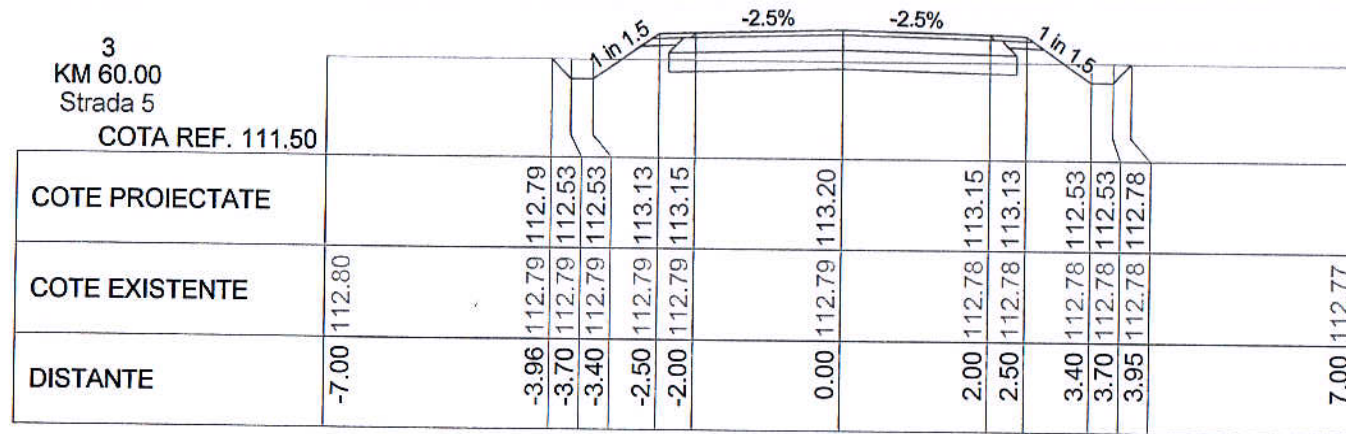

 S.C. "DROMCONS" S.R.L. SEBIS, str. Codrului nr. 1 C.U.I 15624428 J02/9/12/2003 tel : +40(0)743 119 667, tel / fax: +40(0)357 437 554 e-mail : office@dromcons.ro		BENEFICIAR:	COMUNA VLADIMIRESCU	PROIECT NR.	
		DENUMIRE PROIECT:	Amenajare străzi zonă locuințe, Vladimirescu zonă nouă, județul Arad	62/2013	
SEF PROIECT: dpl. ing. ADRIAN PRAHOVEANU <i>[Signature]</i>		OBIECT:	DRUMURI	D.T.+C.S.	
PROIECTAT Dpl. Ing. FLORE CRISTIAN <i>[Signature]</i>		SCARA:	1:1000 1:100	PLANSĂ NR.	03D-15
DESENAT: Dpl. Ing. FLORE CRISTIAN <i>[Signature]</i>			2013		
			PROFILURI TRANSVERSALE CURENTE Strada 4		

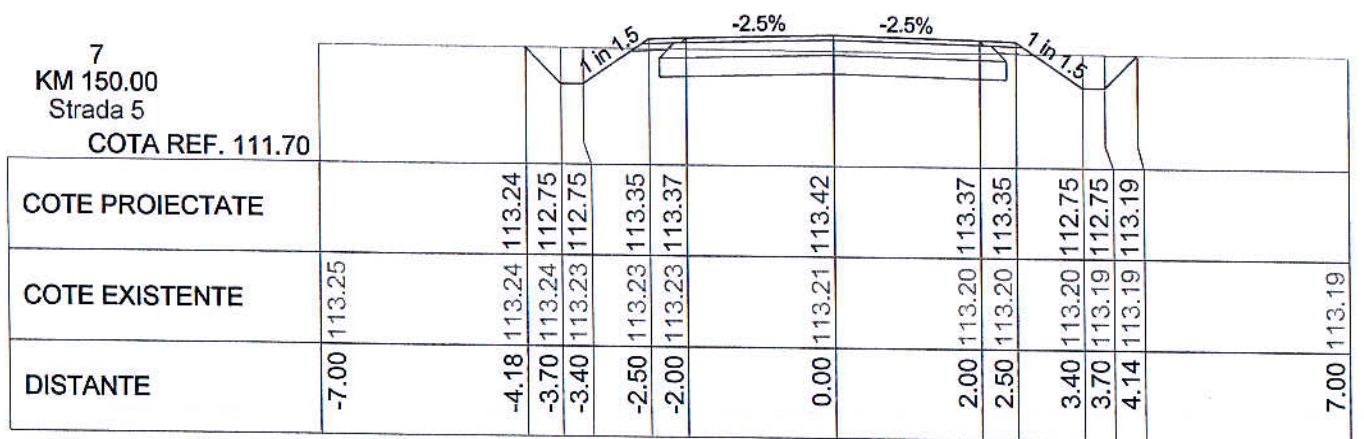
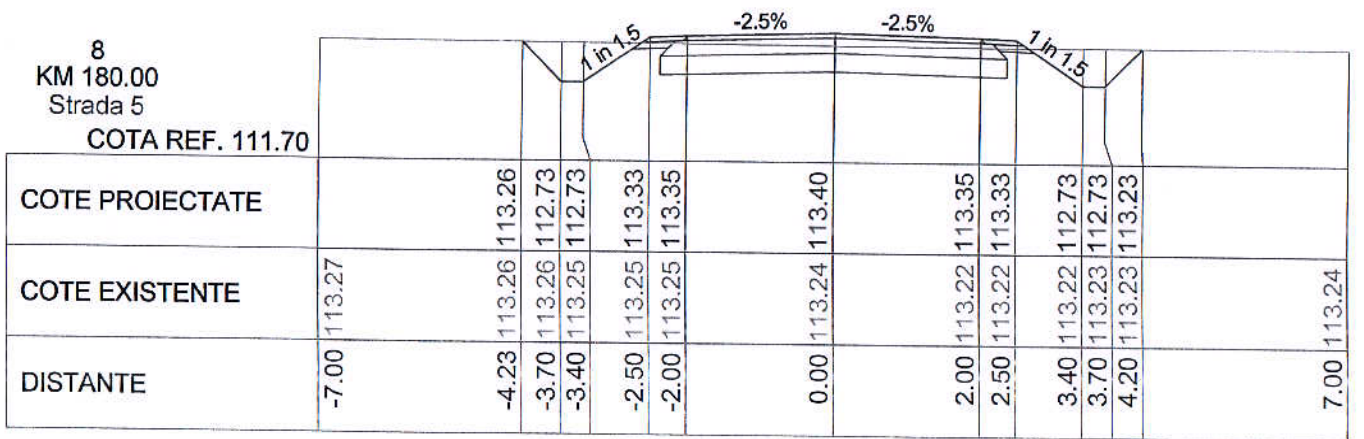
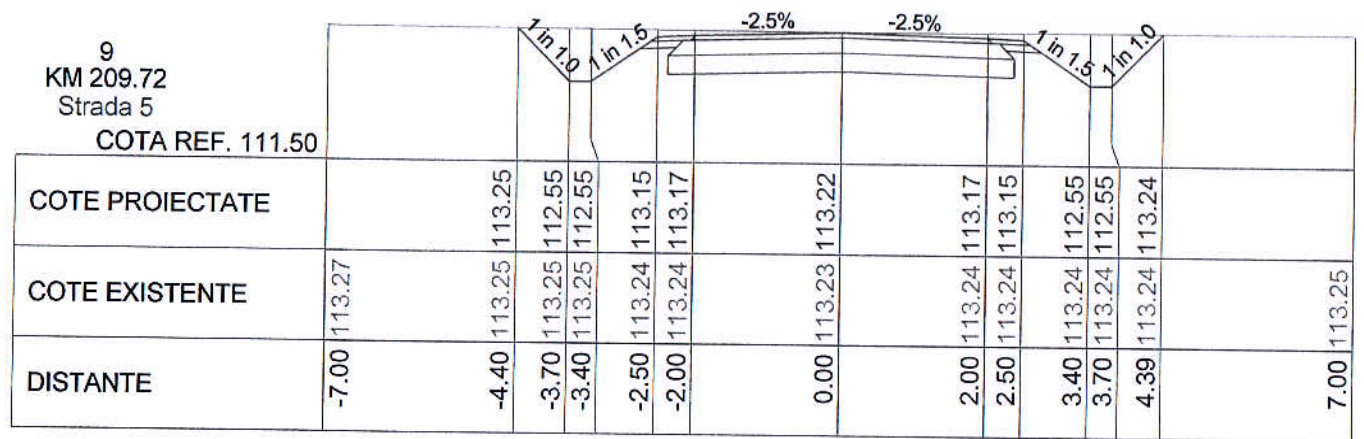

 S.C. "DROMCONS" S.R.L. SEBIS, str. Codrului nr. 1 C.U.I 15624428 J02/912/2003 tel : +40(0)743 119 667, tel / fax: +40(0)357 437 554 e-mail : office@dromcons.ro	BENEFICIAR:	COMUNA VLADIMIRESCU	PROIECT NR.
	DENUMIRE PROIECT:	Amenajare străzi zonă locuințe, Vladimirescu zonă nouă, județul Arad	62/2013
SEF PROIECT:	dpl. ing. ADRIAN PRAHOVEANU	OBIECT:	DRUMURI
PROIECTAT	Dpl. Ing. FLORE CRISTIAN	SCARA:	D.T.+C.S.
DESEMAT:	Dpl. Ing. FLORE CRISTIAN	2013	PLANSĂ NR. 03D-16
		PROFILURI TRANSVERSALE CURENTE	
		Strada 5	



 S.C. "DROMCONS" S.R.L. SEBIS, str. Codrului nr. 1 C.U.I 15624428 J02/912/2003 tel : +40(0)743 119 667, tel / fax: +40(0)357 437 554 e-mail : office@dromcons.ro	 DENUMIRE PROIECT:	BENEFICIAR: COMUNA VLADIMIRESCU Denumire proiect: Amenajare străzi zonă locuințe, Vladimirescu zonă nouă, județul Arad	PROIECT NR. 62/2013
	 OBIECT: DRUMURI	SCARA: 1:1000 1:100 2013	PROFILURI TRANSVERSALE CURENTE Strada 5
SEF PROIECT: dpl. ing. ADRIAN PRAHOVEANU <i>[Signature]</i>	PROIECTAT: Dpl. Ing. FLORE CRISTIAN <i>[Signature]</i>	DESENAT: Dpl. Ing. FLORE CRISTIAN <i>[Signature]</i>	

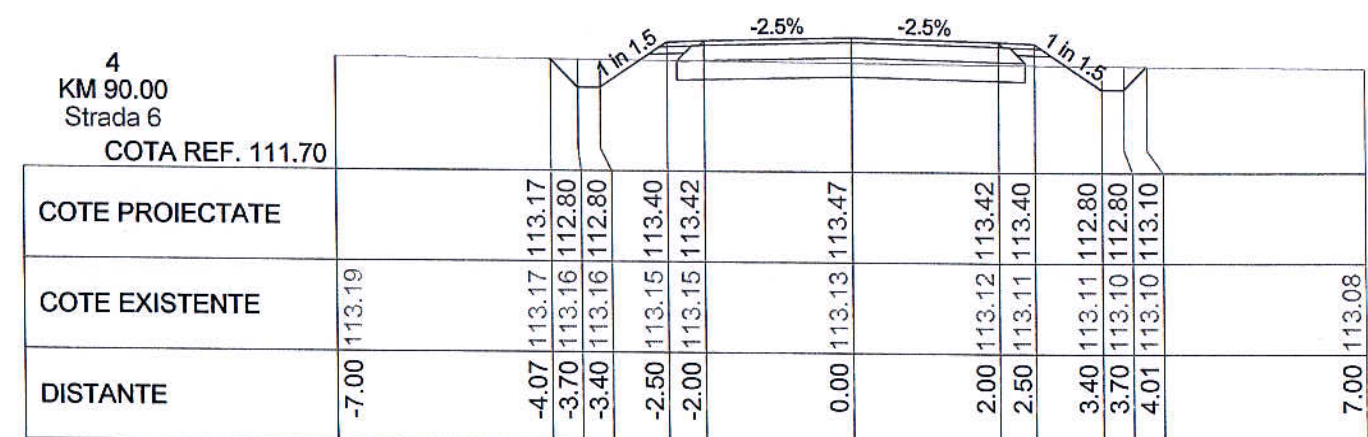
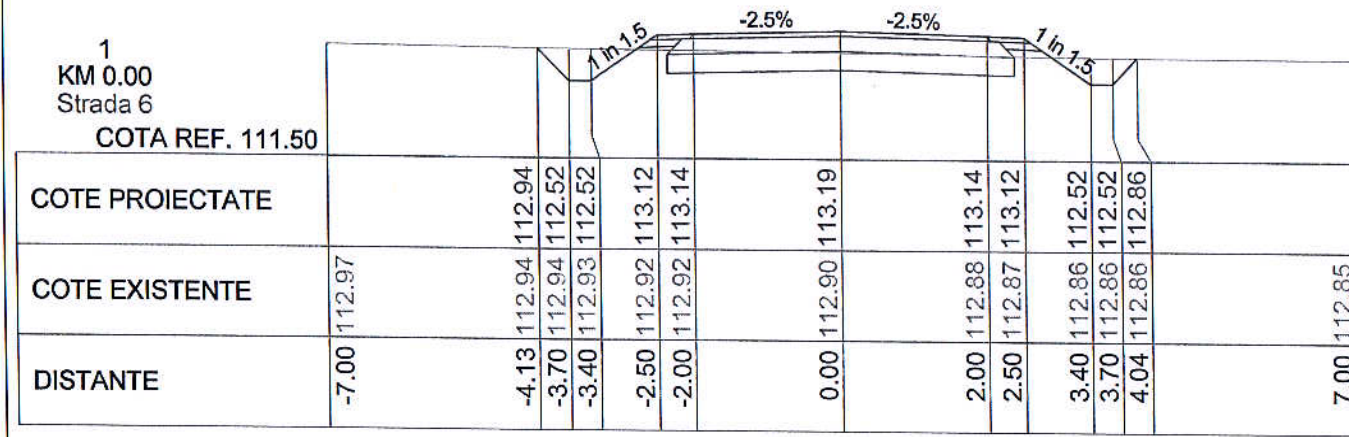
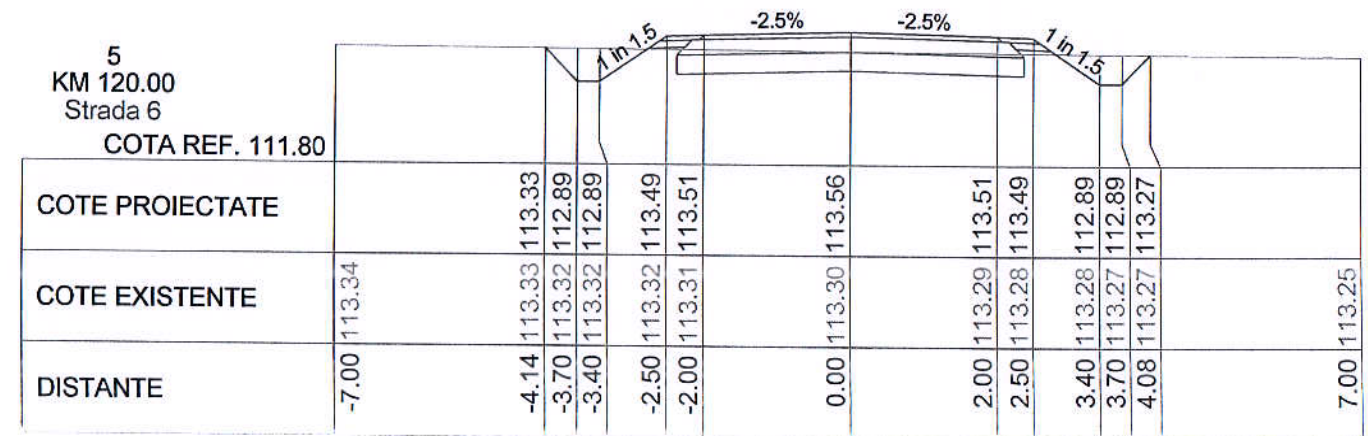
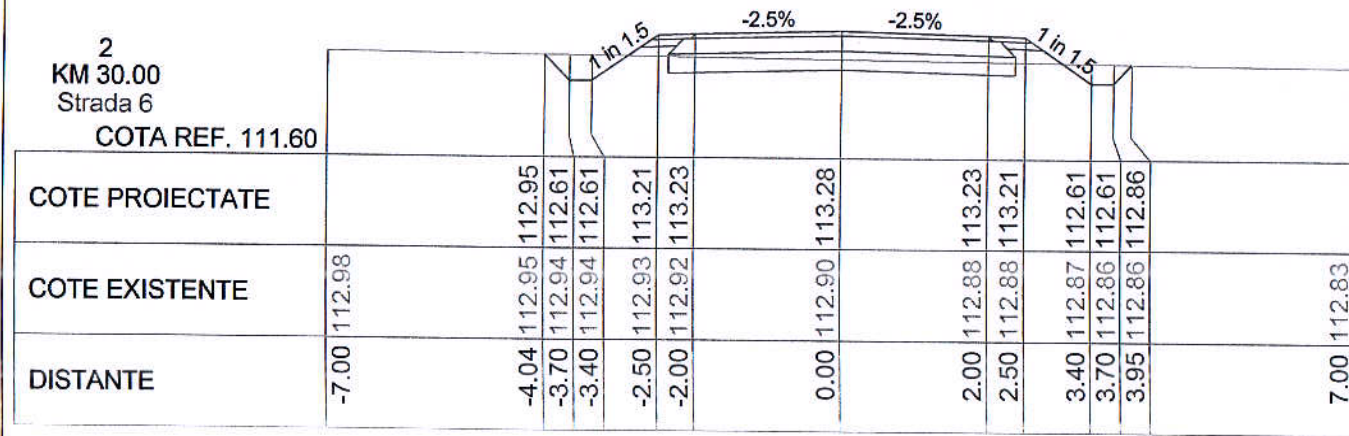
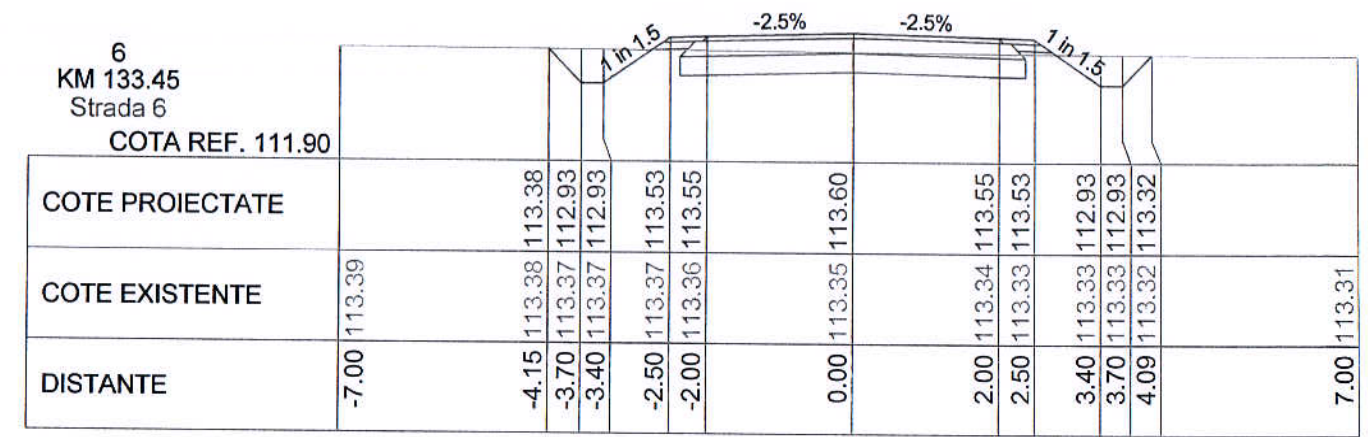
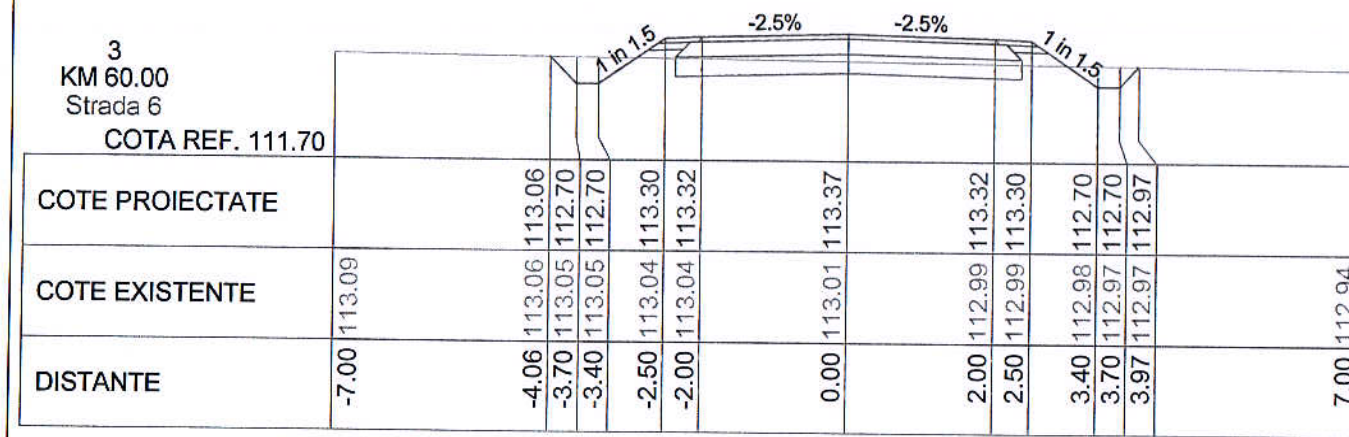

 S.C. "DROMCONS" S.R.L. SEBIS, str. Codrului nr. 1 C.U.I 15624428 J02/912/2003 tel : +40(0)743 119 667, tel / fax: +40(0)357 437 554 e-mail : office@dromcons.ro		BENEFICIAR:	COMUNA VLADIMIRESCU	PROIECT NR.
		DENUMIRE PROIECT:	Amenajare străzi zonă locuințe, Vladimirescu zonă nouă, județul Arad	62/2013
SEF PROIECT:	dpl. ing. ADRIAN PRAHOVEANU	OBIECT:	DRUMURI	D.T.+C.S.
PROIECTAT	Dpl. Ing. FLORE CRISTIAN	SCARA:	1:1000 1:100	PROFILURI TRANSVERSALE CURENTE Strada 6
DESENAT:	Dpl. Ing. FLORE CRISTIAN	2013	2013	

9
KM 210.00
Strada 6
COTA REF. 111.70

COTE PROIECTATE																					
COTE EXISTENTE	113.19																				
DISTANTE	-7.00	-4.18	-3.70	-3.40	-2.50	-2.00	0.00	2.00	2.50	3.40	3.70	4.22								7.00	

8
KM 180.00
Strada 6
COTA REF. 111.80

COTE PROIECTATE																					
COTE EXISTENTE	113.45																				
DISTANTE	-7.00	-4.25	-3.70	-3.40	-2.50	-2.00	0.00	2.00	2.50	3.40	3.70	4.20								7.00	

7
KM 150.00
Strada 6
COTA REF. 111.90

COTE PROIECTATE																					
COTE EXISTENTE	113.46																				
DISTANTE	-7.00	-4.21	-3.70	-3.40	-2.50	-2.00	0.00	2.00	2.50	3.40	3.70	4.16								7.00	

10
KM 212.67
Strada 6
COTA REF. 111.60

COTE PROIECTATE																					
COTE EXISTENTE	113.17																				
DISTANTE	-7.00	-4.18	-3.70	-3.40	-2.50	-2.00	0.00	2.00	2.50	3.40	3.70	4.16								7.00	



 S.C. "DROMCONS" S.R.L. SEBIS, str. Codrul nr. 1 C.U.I 15624428 J02/9/12/2003 tel : +40(0)743 119 667, tel / fax: +40(0)357 437 554 e-mail : office@dromcons.ro	BENEFICIAR:	COMUNA VLADIMIRESCU	PROIECT NR.
	DENUMIRE PROIECT:	Amenajare străzi zonă locuințe, Vladimirescu zonă nouă, județul Arad	62/2013
SEF PROIECT:	dpl. ing. ADRIAN PRAHOVEANU	OBIECT:	DRUMURI
PROIECTAT	Dpl. Ing. FLORE CRISTIAN	SCARA:	1:1000 1:100
DESENAT:	Dpl. Ing. FLORE CRISTIAN		2013
		PROFILURI TRANSVERSALE CURENTE Strada 6	D.T.+C.S. PLANSĂ NR. 03D-19

3
KM 60.00
Strada 7
COTA REF. 112.00

COTE PROIECTATE													
COTE EXISTENTE	113.38	113.38	113.38	113.38	113.62	113.64		113.38	113.62	113.38			
DISTANTE	-7.00	-4.07	-3.70	-3.40	-2.50	-2.00	0.00	2.00	2.50	3.40	3.70	4.07	7.00

6
KM 133.45
Strada 7
COTA REF. 112.10

COTE PROIECTATE													
COTE EXISTENTE	113.62	113.62	113.62	113.62	113.75	113.77		113.61	113.82	113.77	113.75	113.60	113.60
DISTANTE	-7.00	-4.17	-3.70	-3.40	-2.50	-2.00	0.00	2.00	2.50	3.40	3.70	4.15	7.00

2
KM 30.00
Strada 7
COTA REF. 111.90

COTE PROIECTATE													
COTE EXISTENTE	113.36	113.35	112.96	112.96	113.56	113.58		113.35	113.63	113.58	113.56		
DISTANTE	-7.00	-4.09	-3.70	-3.40	-2.50	-2.00	0.00	2.00	2.50	3.40	3.70	4.06	7.00

5
KM 120.00
Strada 7
COTA REF. 112.10

COTE PROIECTATE													
COTE EXISTENTE	113.50	113.50	113.12	113.12	113.72	113.74		113.49	113.79	113.74	113.72	113.12	113.12
DISTANTE	-7.00	-4.07	-3.70	-3.40	-2.50	-2.00	0.00	2.00	2.50	3.40	3.70	4.04	7.00

1
KM 0.00
Strada 7
COTA REF. 111.90

COTE PROIECTATE													
COTE EXISTENTE	113.31	113.30	112.91	112.91	113.51	113.53		113.30	113.58	113.53	113.51		
DISTANTE	-7.00	-4.09	-3.70	-3.40	-2.50	-2.00	0.00	2.00	2.50	3.40	3.70	4.08	7.00

4
KM 90.00
Strada 7
COTA REF. 112.00

COTE PROIECTATE													
COTE EXISTENTE	113.49	113.47	113.07	113.07	113.67	113.69		113.45	113.74	113.69	113.67	113.07	113.07
DISTANTE	-7.00	-4.10	-3.70	-3.40	-2.50	-2.00	0.00	2.00	2.50	3.40	3.70	4.03	7.00



<p>SEBIS, str. Codrului nr. 1 C.U.I 15624428 J02/9/12/2003 tel : +40(0)743 119 667, tel / fax : +40(0)357 437 554 e-mail : office@dromcons.ro</p>	<p>S.C. "DROMCONS" S.R.L.</p>	BENEFICIAR:	COMUNA VLADIMIRESCU	PROIECT NR.	
		DENUMIRE PROIECT:	Amenajare străzi zonă locuințe, Vladimirescu zonă nouă, județul Arad		62/2013
		OBIECT:	DRUMURI		
SEF PROIECT:	dpl. Ing. ADRIAN PRAHOVEANU	SCARA:			D.T.+C.S.
PROIECTAT	Dpl. Ing. FLORE CRISTIAN	1:1000 1:100	PROFILURI TRANSVERSALE CURENTE Strada 7		PLANSA NR. 03D-20
DESENAT:	Dpl. Ing. FLORE CRISTIAN	2013			

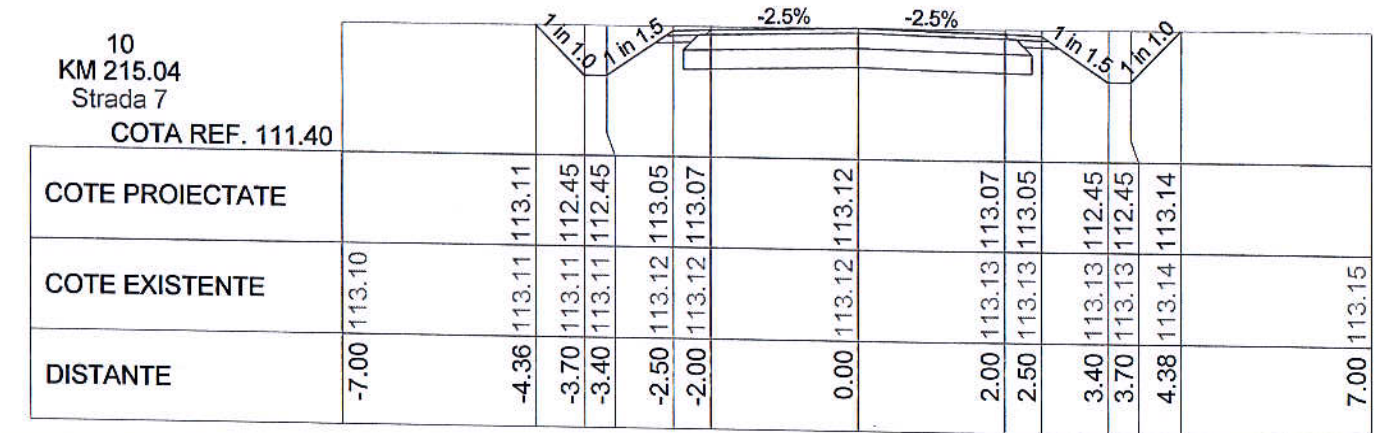
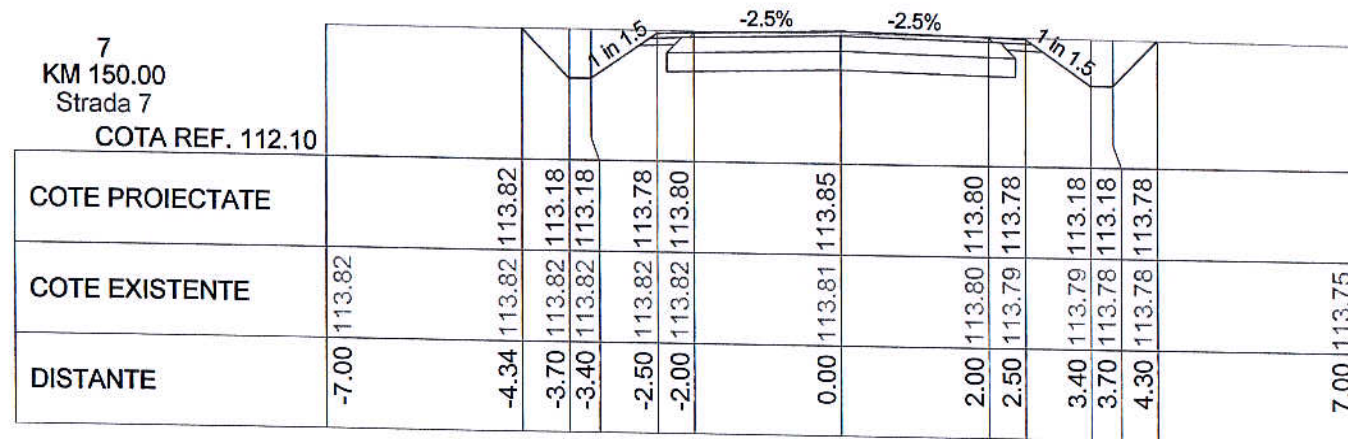
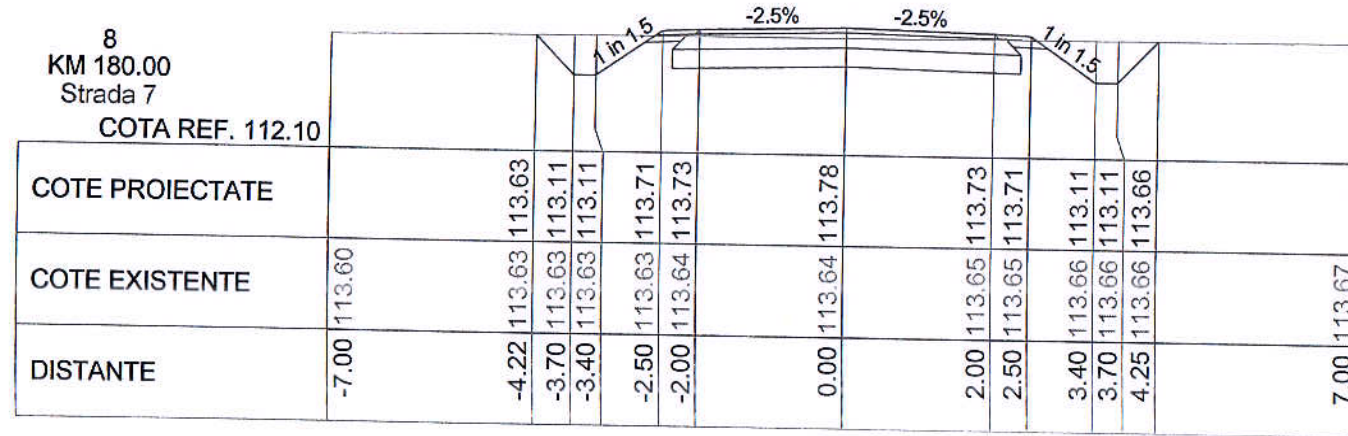
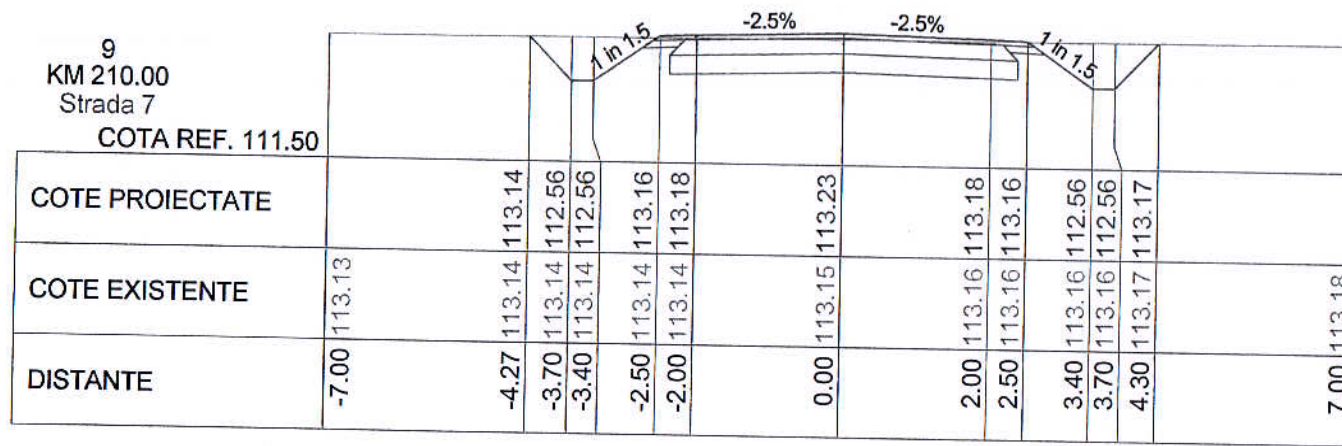

 S.C. "DROMCONS" S.R.L. SEBIS, str. Codrului nr. 1 C.U.I 15624428 J02/912/2003 tel : +40(0)743 119 667, tel / fax: +40(0)357 437 554 e-mail : office@dromcons.ro		BENEFICIAR:	COMUNA VLADIMIRESCU	PROIECT NR.
	DENUMIRE PROIECT:	Amenajare străzi zonă locuințe, Vladimirescu zonă nouă, Județul Arad	62/2013	
SEF PROIECT:	dpl. ing. ADRIAN PRAHOVEANU	OBIECT:	DRUMURI	D.T.+C.S.
PROIECTAT	Dpl. ing. FLORE CRISTIAN	SCARA:	1:1000 1:100	PLANSĂ NR. 03D-21
DESENAT:	Dpl. ing. FLORE CRISTIAN	2013	PROFILURI TRANSVERSALE CURENTE Strada 7	

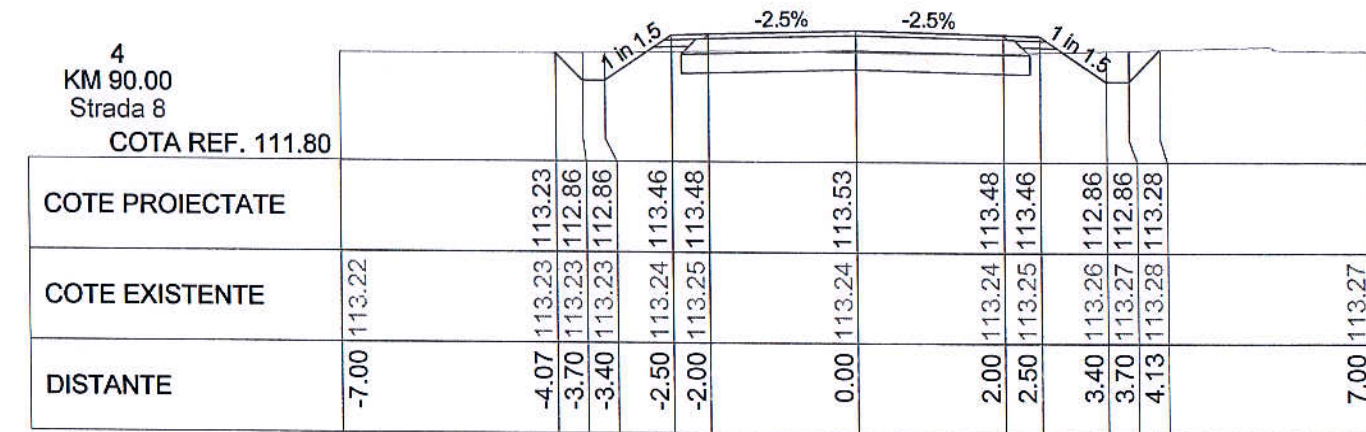
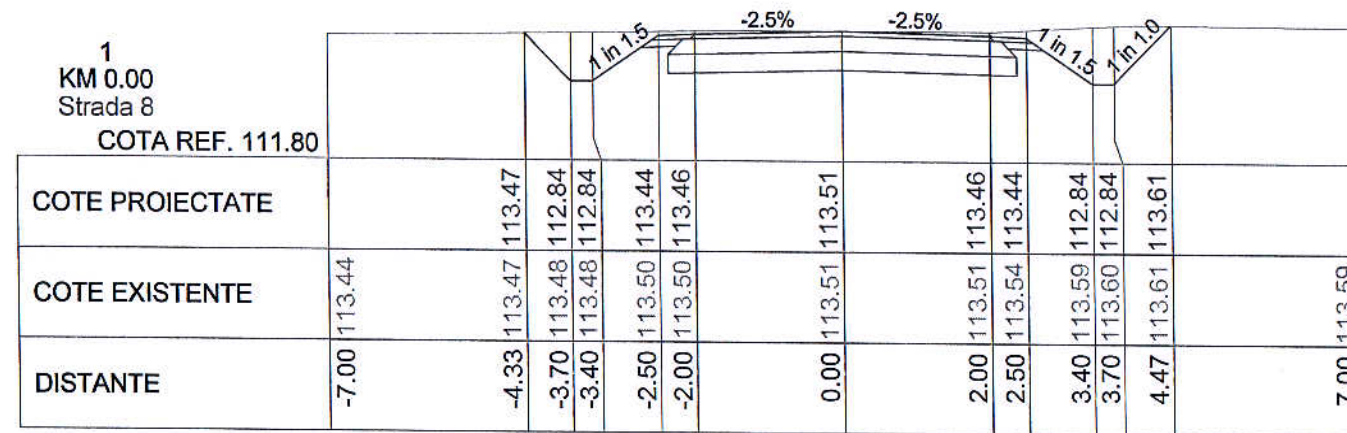
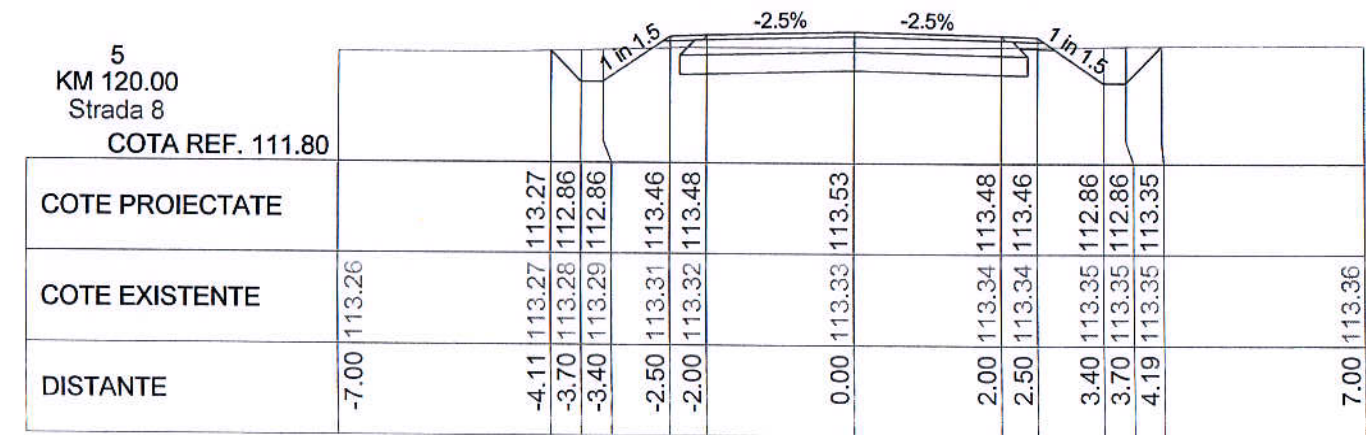
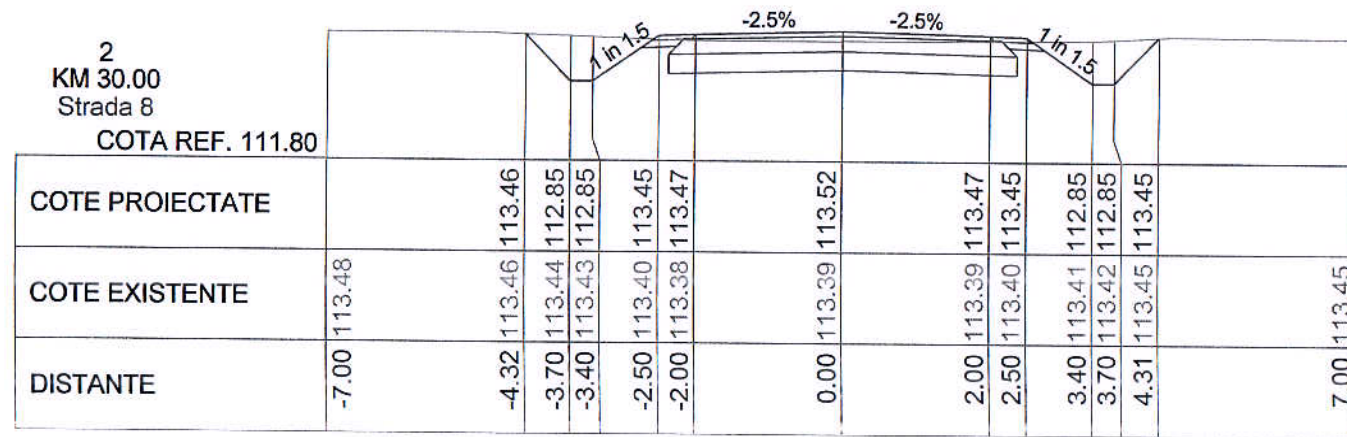
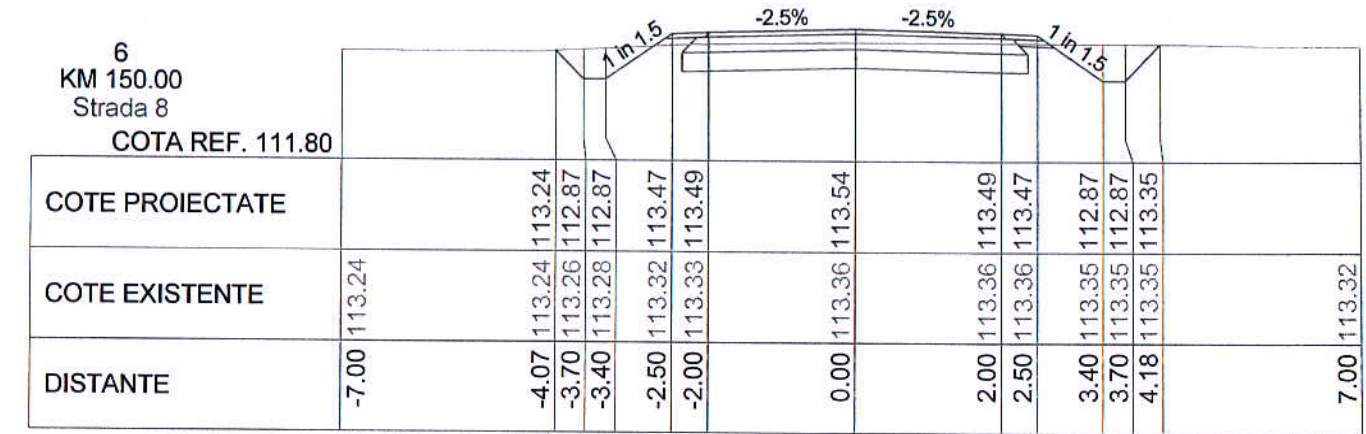
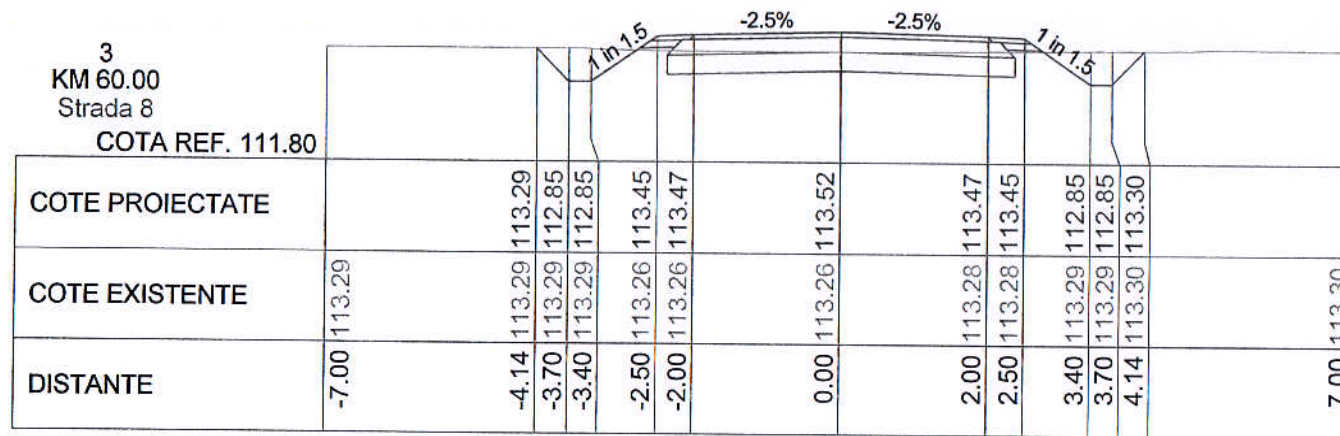

 S.C. "DROMCONS" S.R.L. SEBIS, str. Codrului nr. 1 C.U.I 15624428 J02/9/12/2003 tel : +40(0)743 119 667, tel / fax: +40(0)357 437 554 e-mail : office@dromcons.ro	BENEFICIAR:	COMUNA VLADIMIRESCU	PROIECT NR.
	DENUMIRE PROIECT:	Amenajare străzi zonă locuințe, Vladimirescu zonă nouă, județul Arad	62/2013
	OBIECT:	DRUMURI	D.T.+C.S.
SEF PROIECT:	dpl. ing. ADRIAN PRAHOVEANU	SCARA:	PROFILURI TRANSVERSALE CURENTE Strada 8
PROIECTAT	Dpl. Ing. FLORE CRISTIAN	1:1000 1:100	
DESEANAT:	Dpl. Ing. FLORE CRISTIAN	2013	
			PLANSA NR. 03D-22

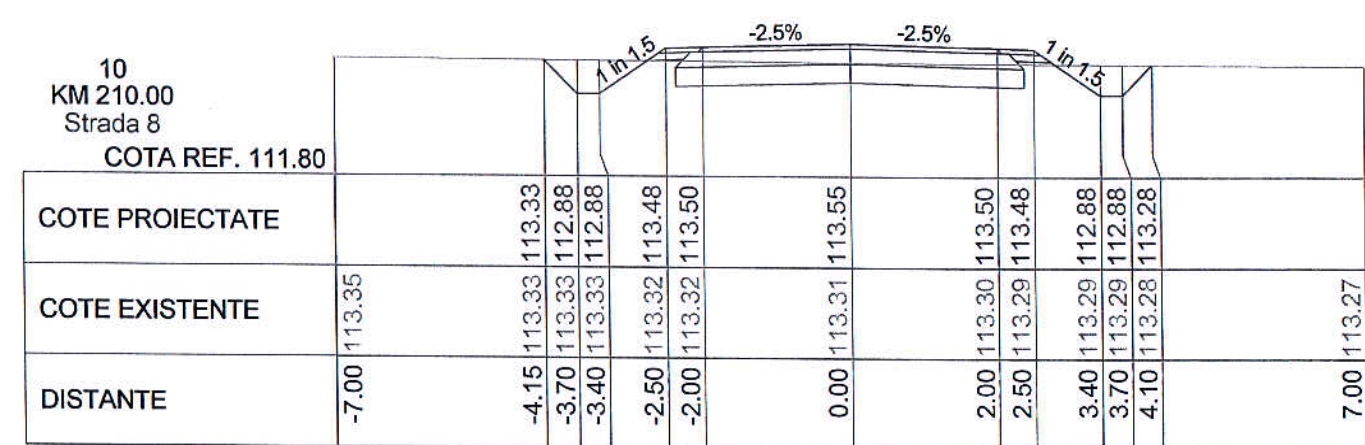
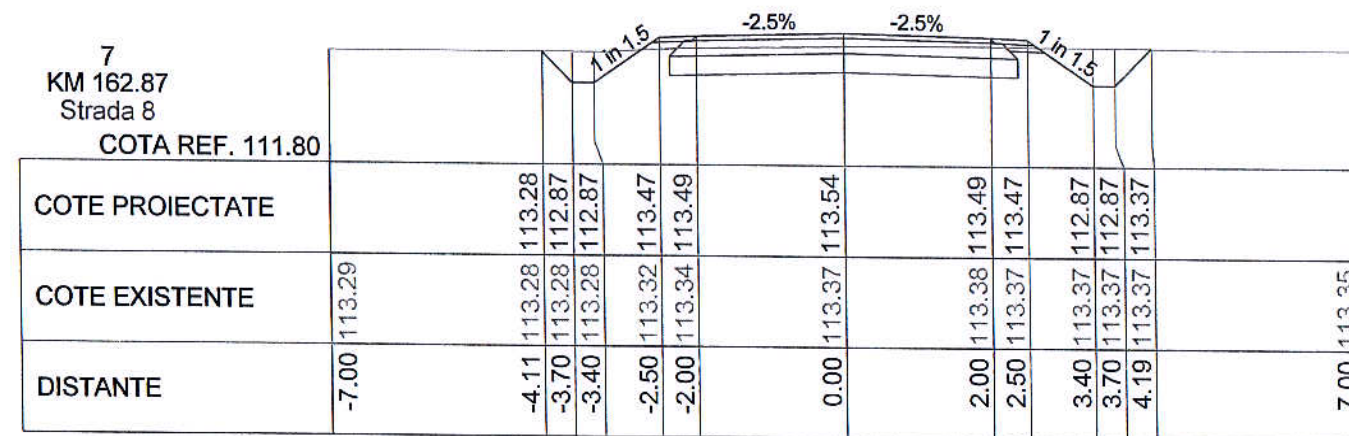
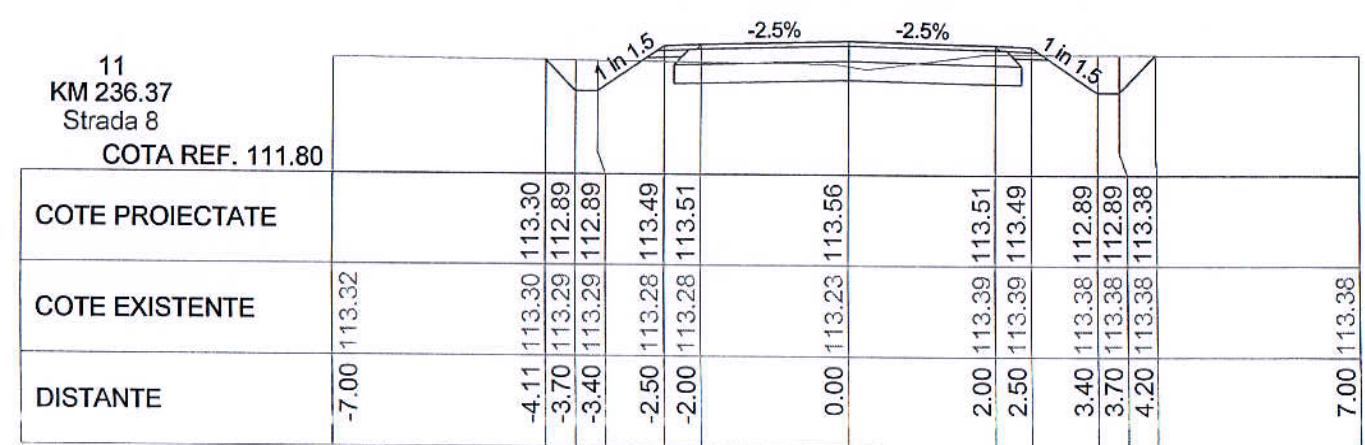
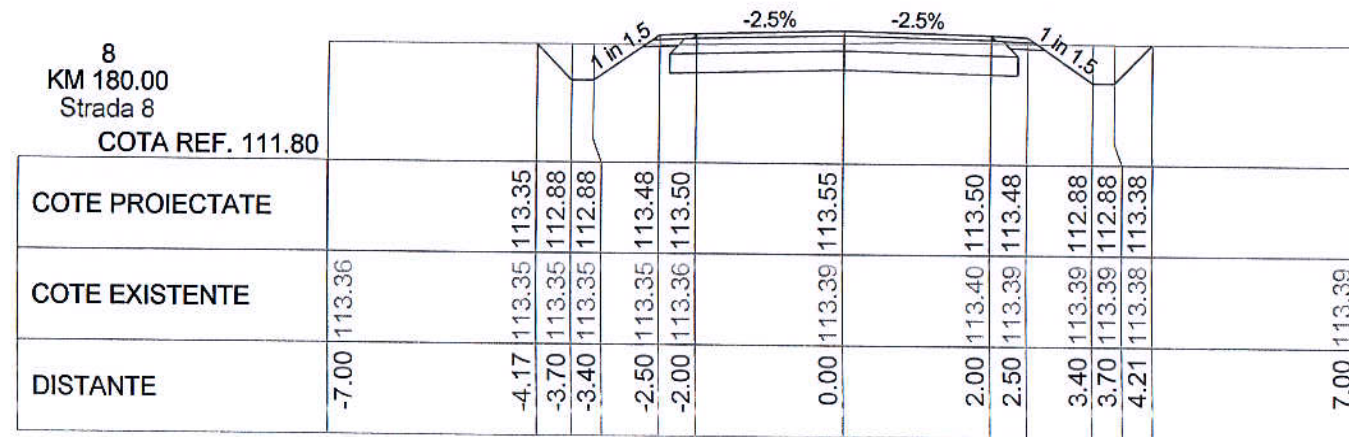
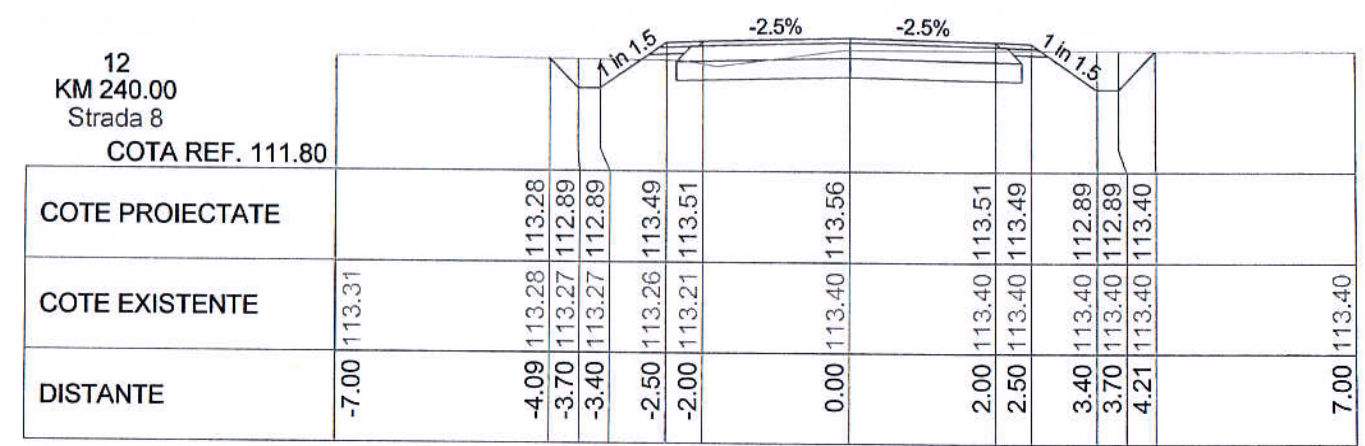
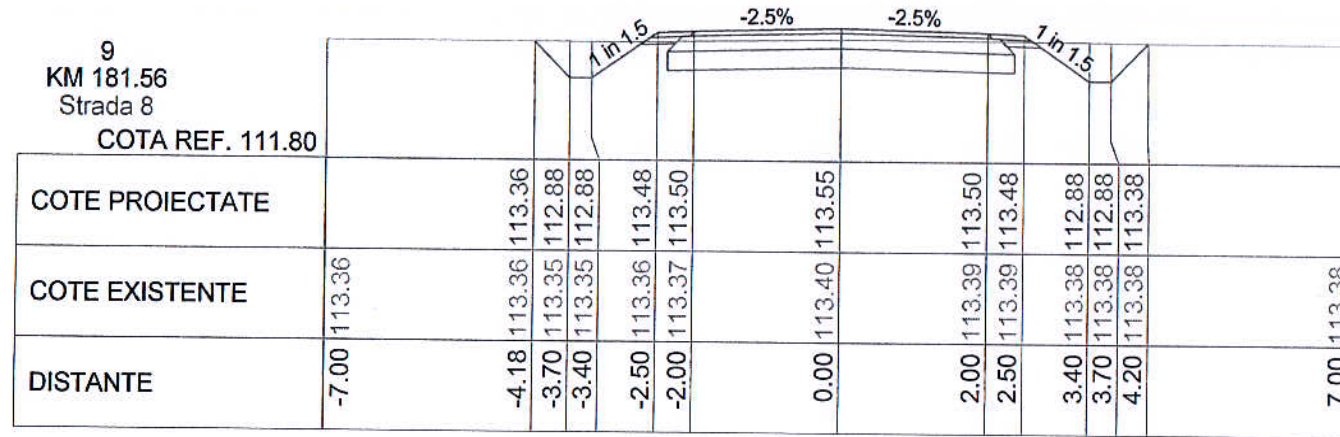

<p>S.C. "DROMCONS" S.R.L. SEBIS, str. Codului nr. 1 C.U.I 15624428 J02/912/2003 tel : +40(0)743 119 667, tel / fax: +40(0)357 437 554 e-mail : office@dromcons.ro</p>	BENEFICIAR:	COMUNA VLADIMIRESCU	PROIECT NR.
	DENUMIRE PROIECT:	Amenajare străzi zonă locuințe, Vladimirescu zonă nouă, județul Arad	62/2013
SEF PROIECT:	dpl. ing. ADRIAN PRAHOVEANU	OBIECT:	DRUMURI
PROIECTAT	Dpl. Ing. FLORE CRISTIAN	SCARA:	D.T.+C.S.
DESEMAT:	Dpl. Ing. FLORE CRISTIAN	1:1000 1:100	PLANSĂ NR. 03D-23
		2013	PROFILURI TRANSVERSALE CURENTE Strada 8

15
 KM 330.00
 Strada 8
 COTA REF. 111.90

COTE PROIECTATE													
COTE EXISTENTE	113.24												
DISTANTE	-7.00	-4.00	-3.70	-3.40	-2.50	-2.00	0.00	2.00	2.50	3.40	3.70	3.97	7.00

18
 KM 369.82
 Strada 8
 COTA REF. 111.90

COTE PROIECTATE													
COTE EXISTENTE	113.22												
DISTANTE	-7.00	-3.99	-3.70	-3.40	-2.50	-2.00	0.00	2.00	2.50	3.40	3.70	3.95	7.00

14
 KM 300.00
 Strada 8
 COTA REF. 111.90

COTE PROIECTATE													
COTE EXISTENTE	113.30												
DISTANTE	-7.00	-4.07	-3.70	-3.40	-2.50	-2.00	0.00	2.00	2.50	3.40	3.70	4.07	7.00

17
 KM 369.79
 Strada 8
 COTA REF. 111.90

COTE PROIECTATE													
COTE EXISTENTE	113.22												
DISTANTE	-7.00	-3.99	-3.70	-3.40	-2.50	-2.00	0.00	2.00	2.50	3.40	3.70	3.95	7.00

13
 KM 270.00
 Strada 8
 COTA REF. 111.90

COTE PROIECTATE													
COTE EXISTENTE	113.36												
DISTANTE	-7.00	-4.16	-3.70	-3.40	-2.50	-2.00	0.00	2.00	2.50	3.40	3.70	4.18	7.00

16
 KM 360.00
 Strada 8
 COTA REF. 111.90

COTE PROIECTATE													
COTE EXISTENTE	113.24												
DISTANTE	-7.00	-3.99	-3.70	-3.40	-2.50	-2.00	0.00	2.00	2.50	3.40	3.70	3.95	7.00



S.C. "DROMCONS" S.R.L.

SEBIS, str. Codrului nr. 1
 C.U.I 15624428 J02/9/12/2003
 tel : +40(0)743 119 667,
 tel / fax: +40(0)357 437 554
 e-mail : office@dromcons.ro



BENEFICIAR:	COMUNA VLADIMIRESCU	PROIECT NR.	
DENUMIRE PROIECT:	Amenajare străzi zonă locuințe, Vladimirescu zonă nouă, Județul Arad		62/2013
OBIECT:	DRUMURI		
SEF PROIECT:	dpl. ing. ADRIAN PRAHOVEANU	SCARA:	D.T.+C.S.
PROIECTAT	Dpl. ing. FLORE CRISTIAN	1:1000 1:100	
DESENAT:	Dpl. ing. FLORE CRISTIAN	2013	PLANSA NR. 03D-24
			PROFILURI TRANSVERSALE CURENTE Strada 8

21
KM 450.00
Strada 8
COTA REF. 111.40

COTE PROIECTATE													
COTE EXISTENTE	112.97									113.04			
DISTANTE	-7.00	-4.23	-3.70	-3.40	-2.50	-2.00	0.00	2.00	2.50	3.40	3.70	4.27	7.00

20
KM 420.00
Strada 8
COTA REF. 111.60

COTE PROIECTATE													
COTE EXISTENTE	113.05												113.12
DISTANTE	-7.00	-4.10	-3.70	-3.40	-2.50	-2.00	0.00	2.00	2.50	3.40	3.70	4.14	7.00

19
KM 390.00
Strada 8
COTA REF. 111.80

COTE PROIECTATE													
COTE EXISTENTE	113.19												113.21
DISTANTE	-7.00	-4.04	-3.70	-3.40	-2.50	-2.00	0.00	2.00	2.50	3.40	3.70	4.03	7.00

22
KM 453.96
Strada 8
COTA REF. 111.40

COTE PROIECTATE													
COTE EXISTENTE	112.95												113.01
DISTANTE	-7.00	-4.23	-3.70	-3.40	-2.50	-2.00	0.00	2.00	2.50	3.40	3.70	4.27	7.00



 S.C. "DROMCONS" S.R.L. SEBIS str. Codrului nr. 1 C.U.I 15624428 J02/912/2003 tel : +40(0)743 119 667, tel / fax: +40(0)357 437 554 e-mail : office@dromcons.ro	BENEFICIAR: COMUNA VLADIMIRESCU DENUMIRE PROIECT: Amenajare străzi zonă locuințe, Vladimirescu zonă nouă, județul Arad OBIECT: DRUMURI	PROIECT NR. 62/2013
	SEF PROIECT: dpl. ing. ADRIAN PRAHOVEANU PROIECTAT: Dpl. Ing. FLORE CRISTIAN DESENAT: Dpl. Ing. FLORE CRISTIAN	SCARA: 1:1000 1:100 2013 PROFILURI TRANSVERSALE CURENTE Strada 8

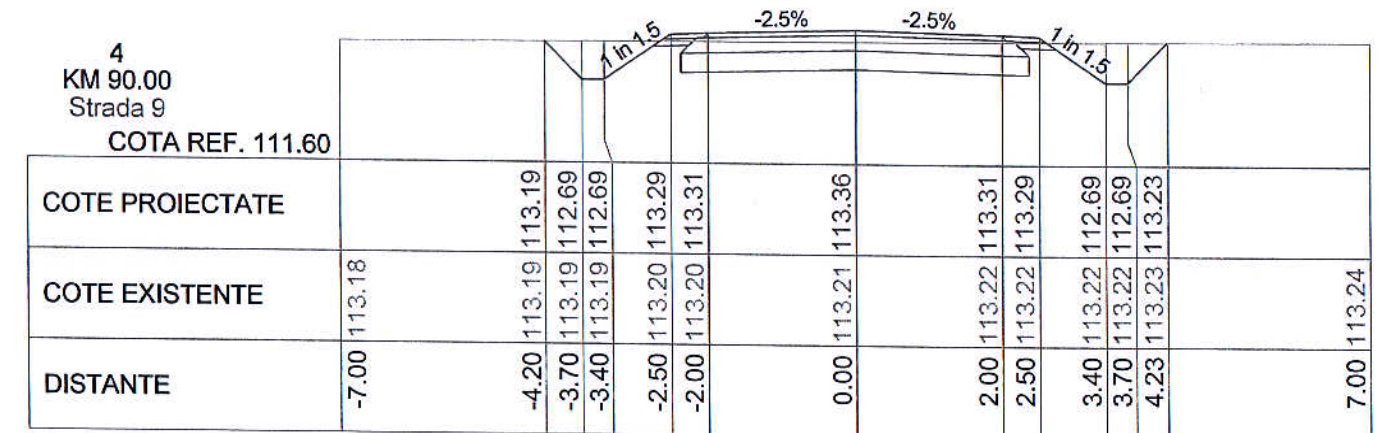
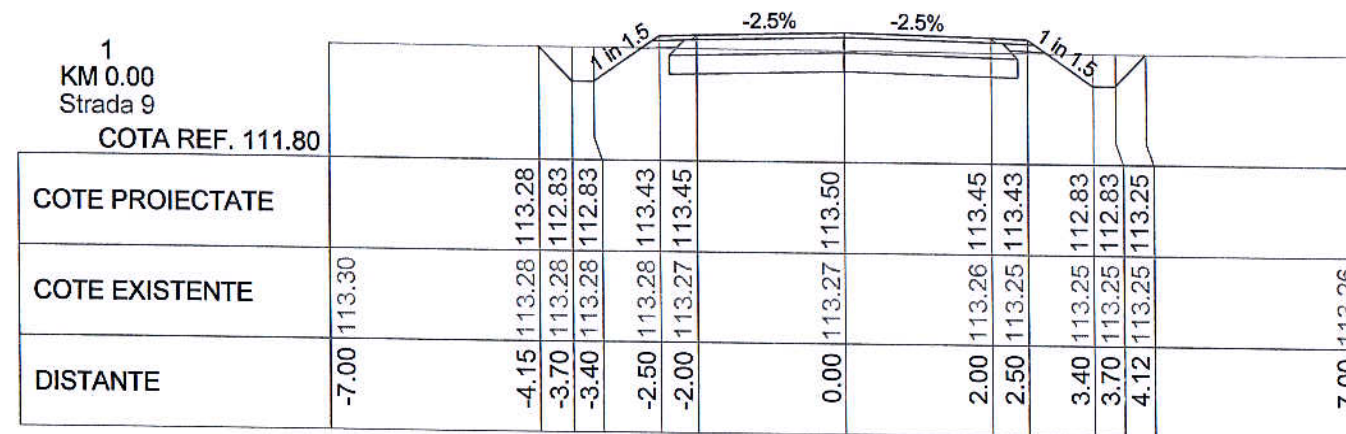
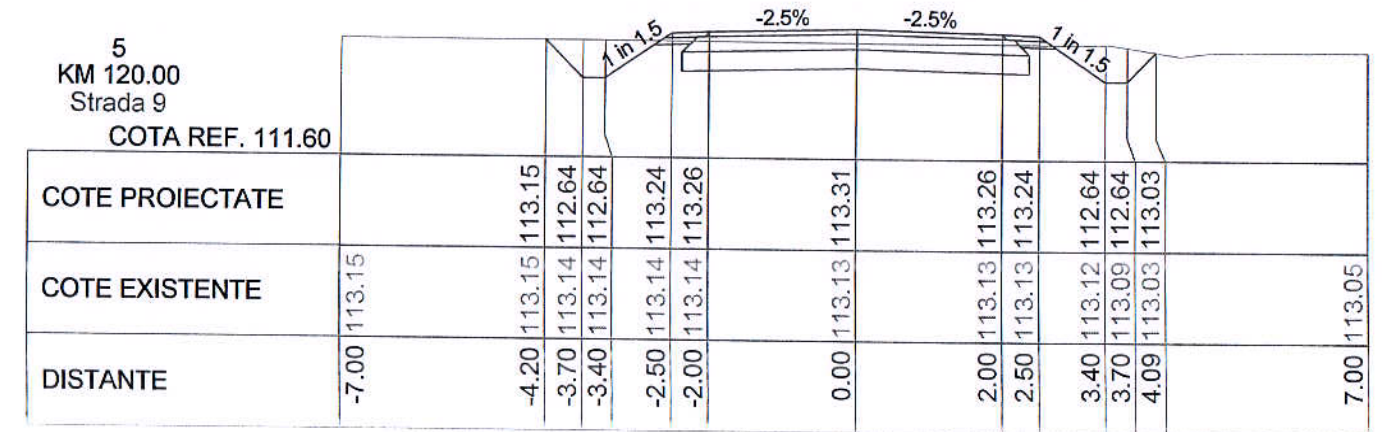
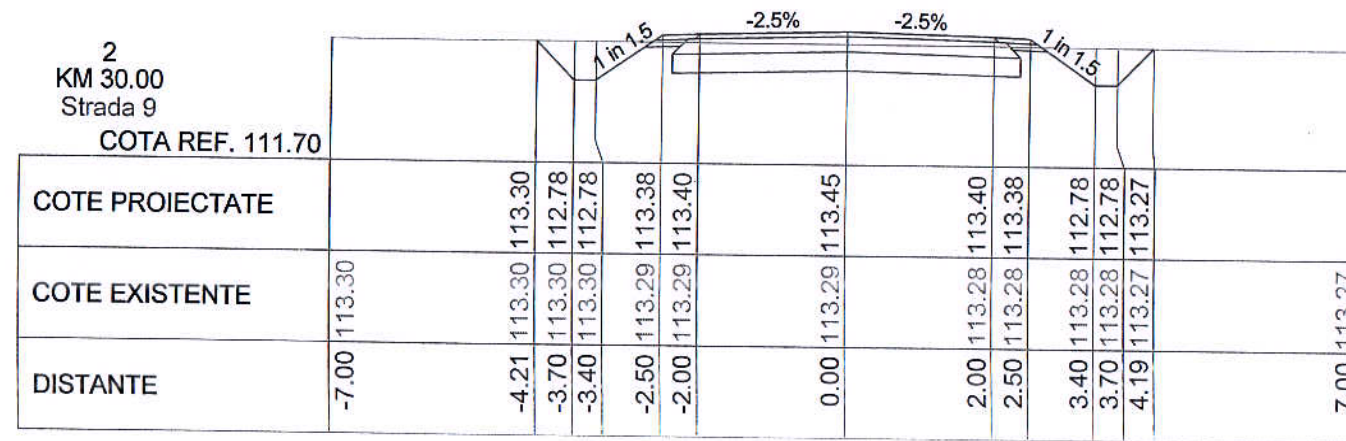
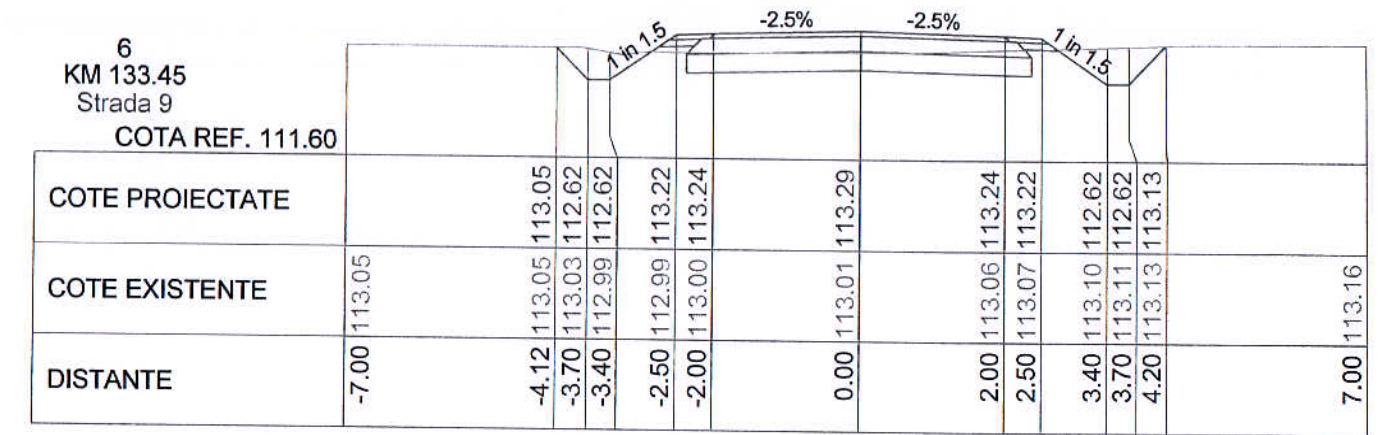
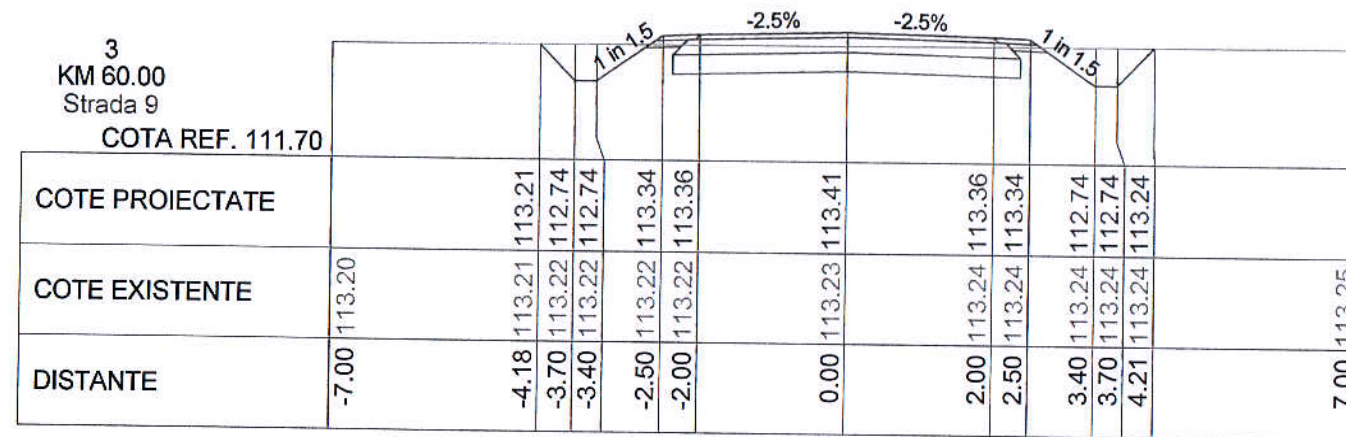

 <p>S.C. "DROMCONS" S.R.L. SEBIS, str. Codrului nr. 1 C.U.I 15624428 J02/912/2003 tel: +40(0)743 119 667 tel / fax: +40(0)357 437 554 e-mail: office@dromcons.ro</p>	BENEFICIAR:	COMUNA VLADIMIRESCU	PROIECT NR.
	DENUMIRE PROIECT:	Amenajare străzi zonă locuințe, Vladimirescu zonă nouă, județul Arad	62/2013
SEF PROIECT:	dpl. ing. ADRIAN PRAHOVEANU	OBIECT:	DRUMURI
PROIECTAT	Dpl. Ing. FLORE CRISTIAN	SCARA:	1:1000 1:100
DESEMAT:	Dpl. Ing. FLORE CRISTIAN		2013
PROFILURI TRANSVERSALE CURENTE Strada 9			D.T.+C.S. PLANSĂ NR. 03D-26

9
KM 210.00
Strada 9

COTA REF. 111.20

COTE PROIECTATE																					
COTE EXISTENTE	112.58																				
DISTANTE	-7.00																				

8
KM 180.00
Strada 9

COTA REF. 111.40

COTE PROIECTATE																					
COTE EXISTENTE	112.79																				
DISTANTE	-7.00																				

7
KM 150.00
Strada 9

COTA REF. 111.50

COTE PROIECTATE																					
COTE EXISTENTE	113.00																				
DISTANTE	-7.00																				

11
KM 265.45
Strada 9

COTA REF. 111.00

COTE PROIECTATE																					
COTE EXISTENTE	112.62																				
DISTANTE	-7.00																				

10
KM 240.00
Strada 9

COTA REF. 111.10

COTE PROIECTATE																					
COTE EXISTENTE	112.60																				
DISTANTE	-7.00																				



 S.C. "DROMCONS" S.R.L. SEBIS, str. Codrului nr. 1 C.U.I 15624428 J02/9/12/2003 tel : +40(0)743 119 667, tel / fax: +40(0)357 437 554 e-mail : office@dromcons.ro	BENEFICIAR:	COMUNA VLADIMIRESCU	PROIECT NR.
	DENUMIRE PROIECT:	Amenajare străzi zonă locuințe, Vladimirescu zonă nouă, județul Arad	62/2013
SEF PROIECT:	dpl. ing. ADRIAN PRAHOVEANU	OBIECT:	DRUMURI
PROIECTAT	Dpl. Ing. FLORE CRISTIAN	SCARA:	1:1000 1:100
DESEMAT:	Dpl. Ing. FLORE CRISTIAN	2013	PROFILURI TRANSVERSALE CURENTE Strada 9
			D.T.+C.S. PLANSĂ NR. 03D-27

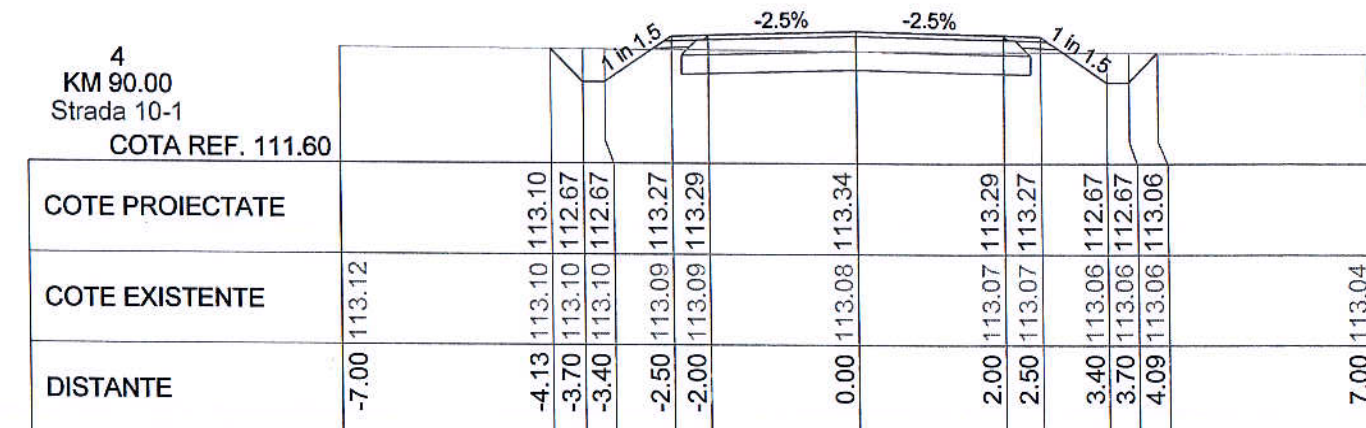
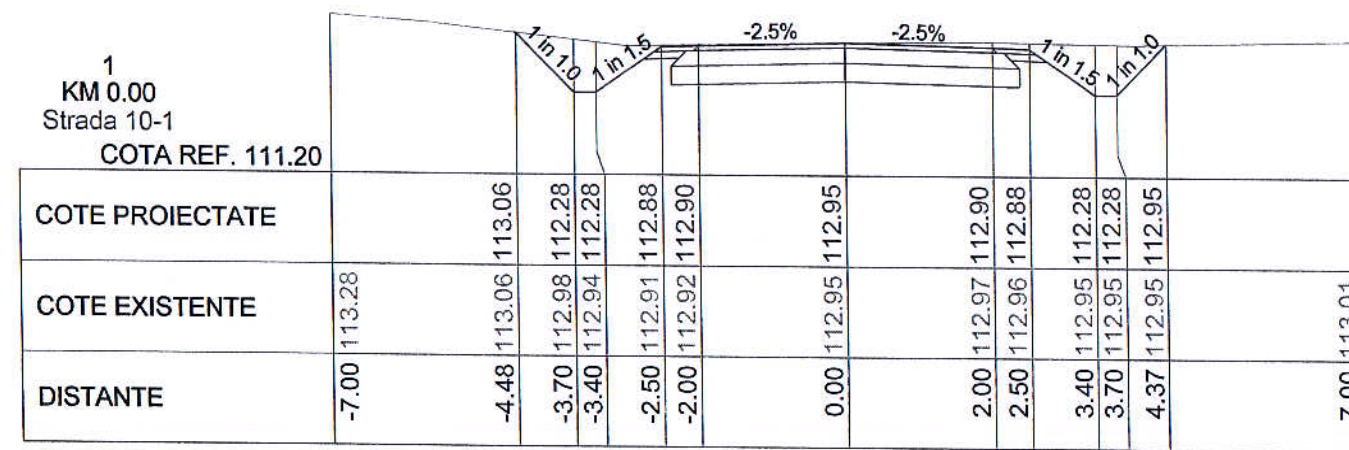
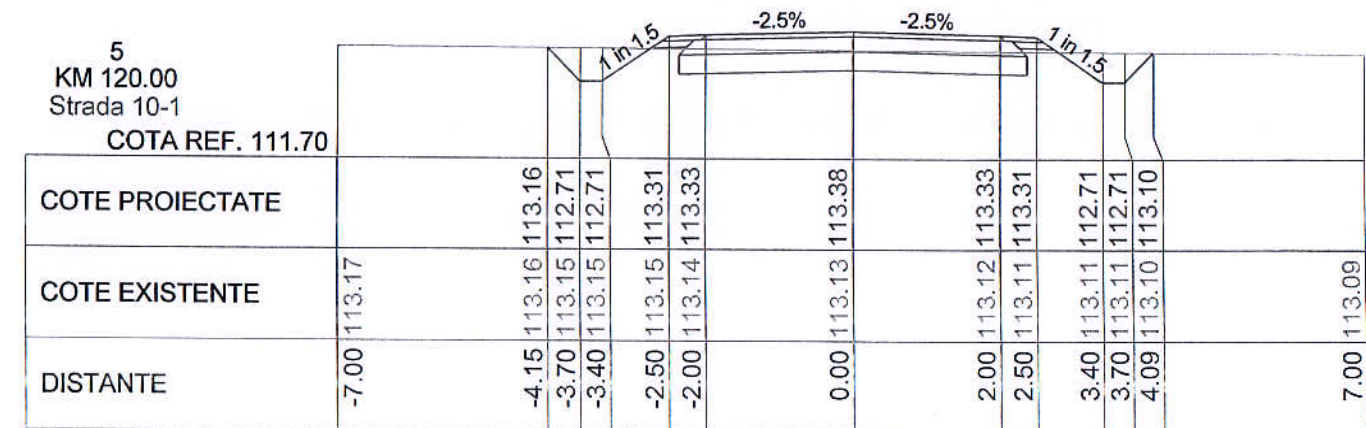
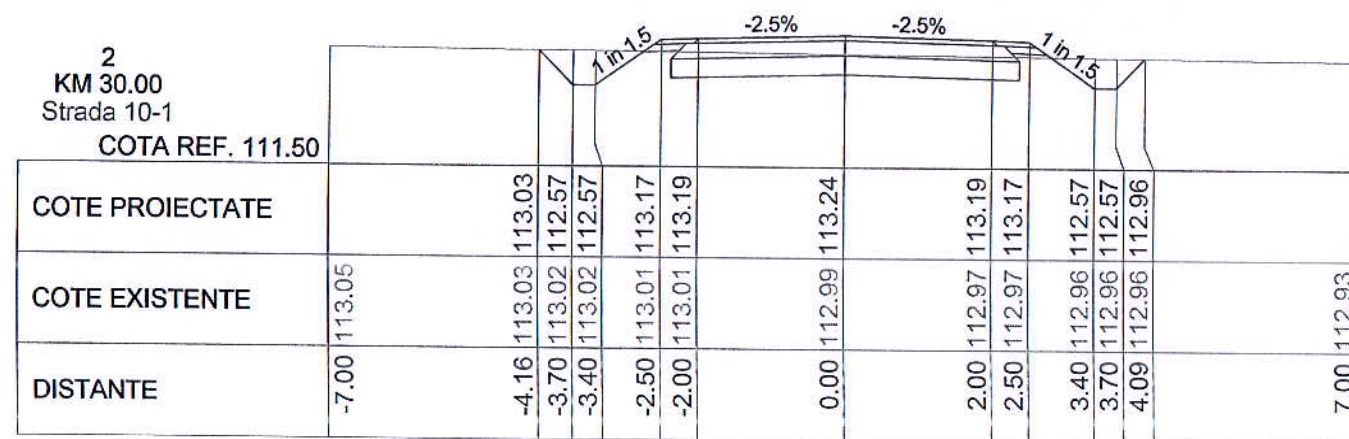
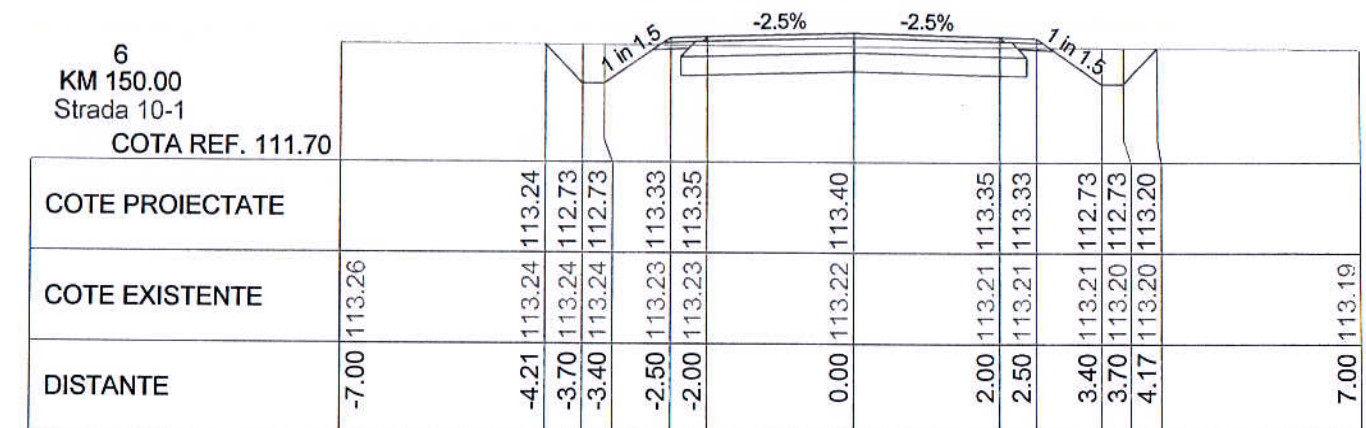
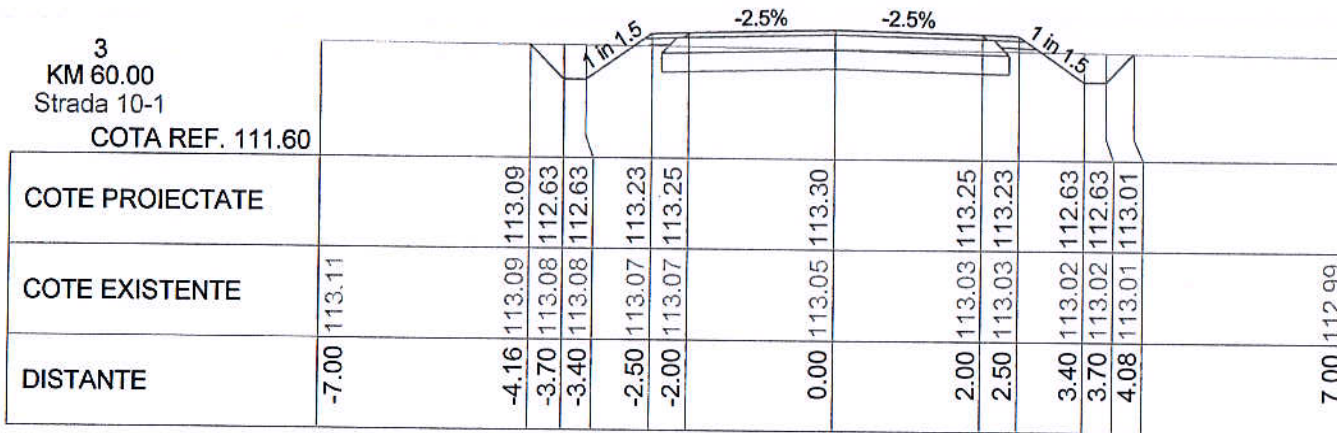

S.C. "DROMCONS" S.R.L. SEBIS, str. Codrului nr. 1 C.U.I 15624428 J02/912/2003 tel: +40(0)743 119 667, tel / fax: +40(0)357 437 554 e-mail : office@dromcons.ro		BENEFICIAR:	COMUNA VLADIMIRESCU	PROIECT NR.
		DENUMIRE PROIECT:	Amenajare străzi zonă locuințe, Vladimirescu zonă nouă, județul Arad	62/2013
SEF PROIECT:	dpl. ing. ADRIAN PRAHOVEANU	OBIECT:	DRUMURI	D.T.+C.S.
PROIECTAT	Dpl. ing. FLORE CRISTIAN	SCARA:	1:1000 1:100	PLANSA NR. 03D-28
DESENAT:	Dpl. ing. FLORE CRISTIAN		2013	
		PROFILURI TRANSVERSALE CURENTE Strada 10		

9
KM 240.00
Strada 10-1
COTA REF. 111.70

COTE PROIECTATE														
COTE EXISTENTE	113.28													
DISTANTE	-7.00	-4.20	-3.70	-3.40	-2.50	-2.00	0.00	2.00	2.50	3.40	3.70	4.15	7.00	113.20

12
KM 330.00
Strada 10-1
COTA REF. 111.60

COTE PROIECTATE														
COTE EXISTENTE	113.13													
DISTANTE	-7.00	-4.14	-3.70	-3.40	-2.50	-2.00	0.00	2.00	2.50	3.40	3.70	4.12	7.00	113.10

8
KM 210.00
Strada 10-1
COTA REF. 111.70

COTE PROIECTATE														
COTE EXISTENTE	113.23													
DISTANTE	-7.00	-4.11	-3.70	-3.40	-2.50	-2.00	0.00	2.00	2.50	3.40	3.70	4.02	7.00	113.12

11
KM 300.00
Strada 10-1
COTA REF. 111.70

COTE PROIECTATE														
COTE EXISTENTE	113.26													
DISTANTE	-7.00	-4.21	-3.70	-3.40	-2.50	-2.00	0.00	2.00	2.50	3.40	3.70	4.15	7.00	113.18

7
KM 180.00
Strada 10-1
COTA REF. 111.70

COTE PROIECTATE														
COTE EXISTENTE	113.19													
DISTANTE	-7.00	-4.06	-3.70	-3.40	-2.50	-2.00	0.00	2.00	2.50	3.40	3.70	3.96	7.00	113.04

10
KM 270.00
Strada 10-1
COTA REF. 111.70

COTE PROIECTATE														
COTE EXISTENTE	113.25													
DISTANTE	-7.00	-4.19	-3.70	-3.40	-2.50	-2.00	0.00	2.00	2.50	3.40	3.70	4.15	7.00	113.19



<p>S.C. "DROMCONS" S.R.L. SEBIS, str. Codrului nr. 1 C.U.I 15624428 JO2/912/2003 tel : +40(0)743 119 667, tel / fax: +40(0)357 437 554 e-mail : office@dromcons.ro</p>	BENEFICIAR:	COMUNA VLADIMIRESCU	PROIECT NR.
	DENUMIRE PROIECT:	Amenajare străzi zonă locuințe, Vladimirescu zonă nouă, județul Arad	62/2013
SEF PROIECT:	dpl. ing. ADRIAN PRAHOVEANU	OBIECT:	DRUMURI
PROIECTAT	Dpl. ing. FLORE CRISTIAN	SCARA:	1:1000 1:100
DESENAT:	Dpl. ing. FLORE CRISTIAN	2013	PROFILURI TRANSVERSALE CURENTE Strada 10
			D.T.+C.S. PLANSĂ NR. 03D-29

15
KM 380.00
Strada 10-1
COTA REF. 111.30

COTE PROIECTATE													
COTE EXISTENTE	112.61									112.69			
DISTANTE	-7.00	-4.06	-3.70	-3.40	-2.50	-2.00	0.00	2.00	2.50	3.40	3.70	4.07	7.00

18
KM 400.00
Strada 10-1
COTA REF. 111.10

COTE PROIECTATE													
COTE EXISTENTE	112.54												112.60
DISTANTE	-7.00	-4.06	-3.70	-3.40	-2.50	-2.00	0.00	2.00	2.50	3.40	3.70	4.10	7.00

14
KM 379.27
Strada 10-1
COTA REF. 111.30

COTE PROIECTATE													
COTE EXISTENTE	112.63												112.69
DISTANTE	-7.00	-4.06	-3.70	-3.40	-2.50	-2.00	0.00	2.00	2.50	3.40	3.70	4.07	7.00

17
KM 390.18
Strada 10-1
COTA REF. 111.20

COTE PROIECTATE													
COTE EXISTENTE	112.52												112.64
DISTANTE	-7.00	-4.00	-3.70	-3.40	-2.50	-2.00	0.00	2.00	2.50	3.40	3.70	4.07	7.00

13
KM 360.00
Strada 10-1
COTA REF. 111.40

COTE PROIECTATE													
COTE EXISTENTE	112.88												112.89
DISTANTE	-7.00	-4.10	-3.70	-3.40	-2.50	-2.00	0.00	2.00	2.50	3.40	3.70	4.11	7.00

16
KM 390.00
Strada 10-1
COTA REF. 111.20

COTE PROIECTATE													
COTE EXISTENTE	112.52												112.64
DISTANTE	-7.00	-4.00	-3.70	-3.40	-2.50	-2.00	0.00	2.00	2.50	3.40	3.70	4.07	7.00



 S.C. "DROMCONS" S.R.L. SEBIS str. Codrul nr. 1 C.U.I 15624428 J02/912/2003 tel : +40(0)743 119 667, tel / fax: +40(0)357 437 554 e-mail : office@dromcons.ro	BENEFICIAR:	COMUNA VLADIMIRESCU	PROIECT NR.
	DENUMIRE PROIECT:	Amenajare străzi zonă locuințe, Vladimirescu zonă nouă, județul Arad	62/2013
	OBIECT:	DRUMURI	
SEF PROIECT:	dpl. ing. ADRIAN PRAHOVEANU	SCARA:	D.T.+C.S.
PROIECTAT	Dpl. Ing. FLORE CRISTIAN	1:1000 1:100	PLANSĂ NR. 03D-30
DESENAT:	Dpl. Ing. FLORE CRISTIAN	2013	
		PROFILURI TRANSVERSALE CURENTE Strada 10	

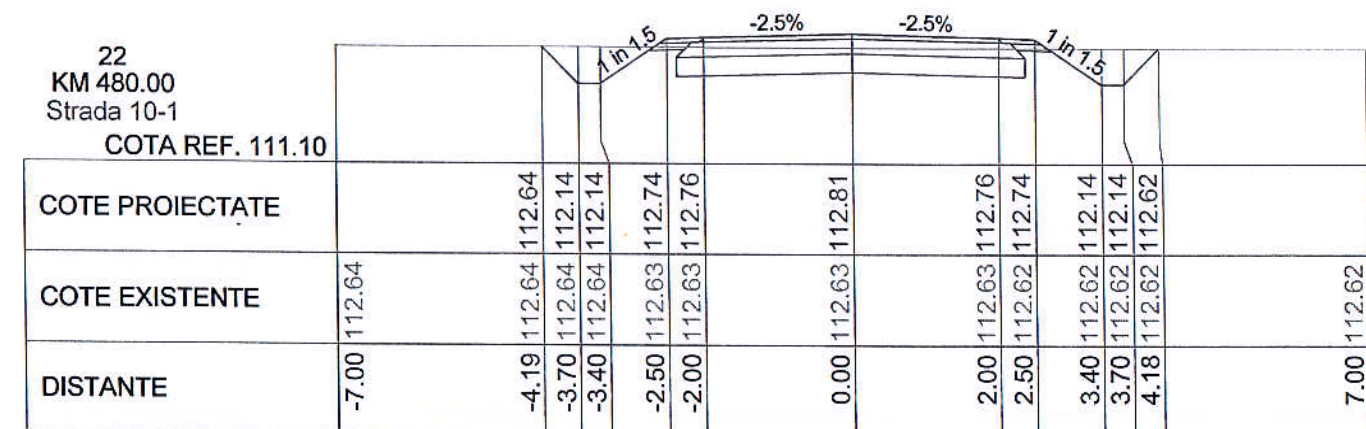
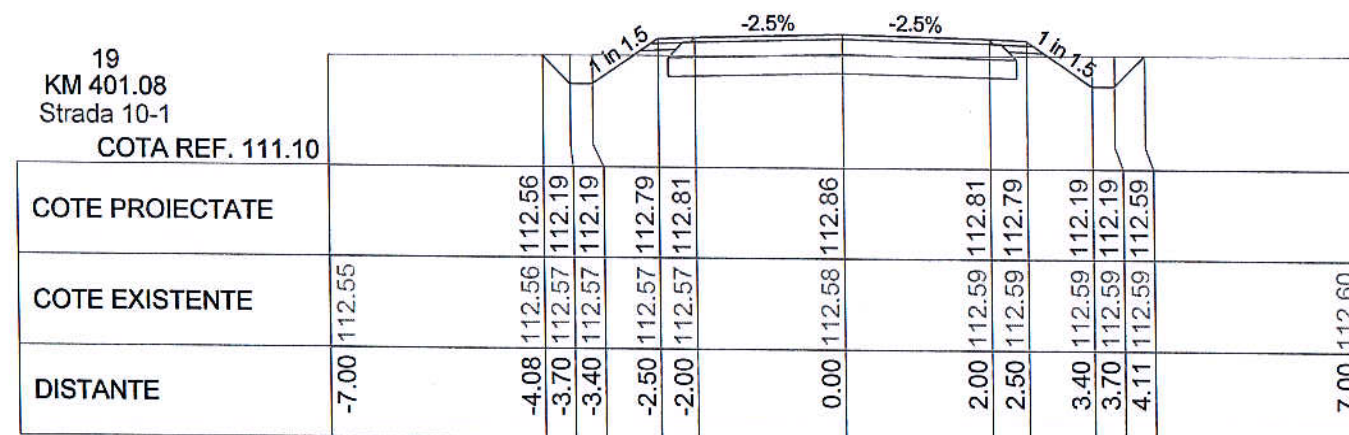
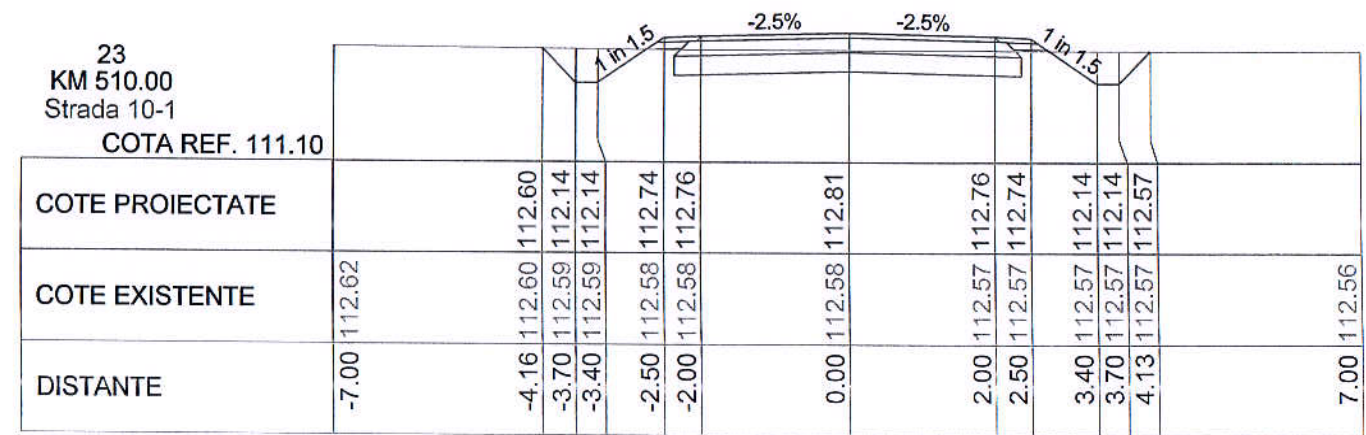
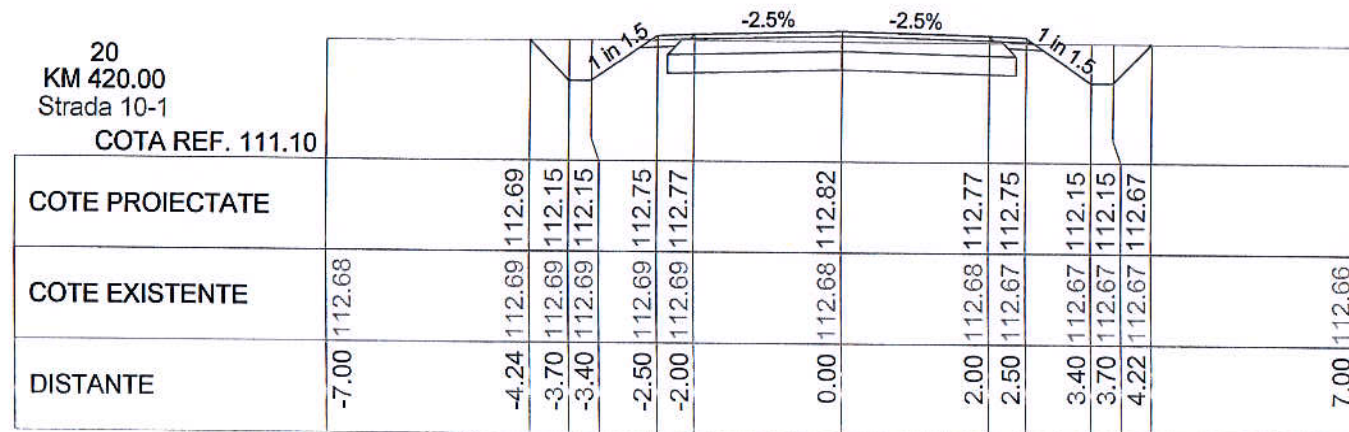
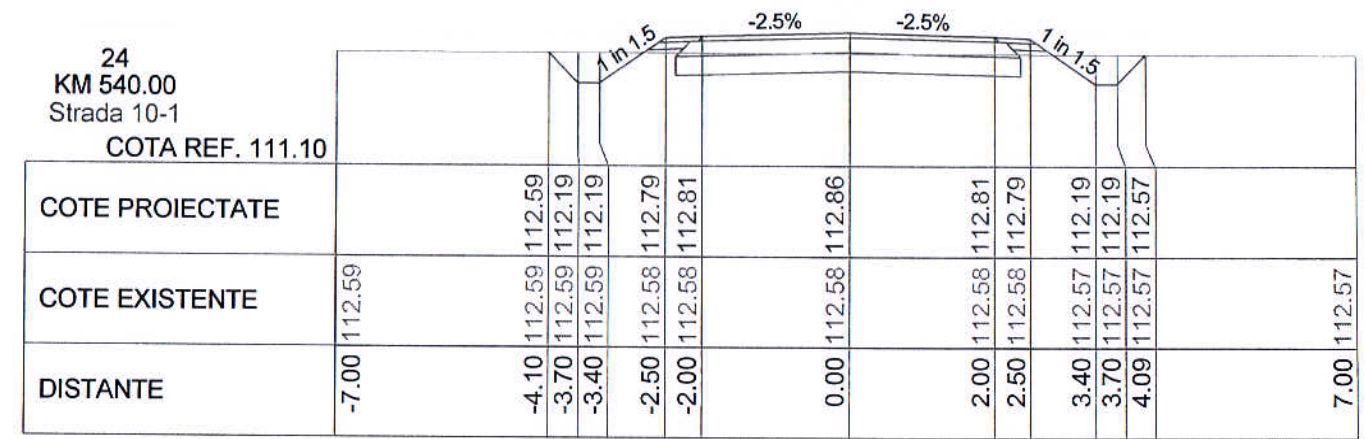
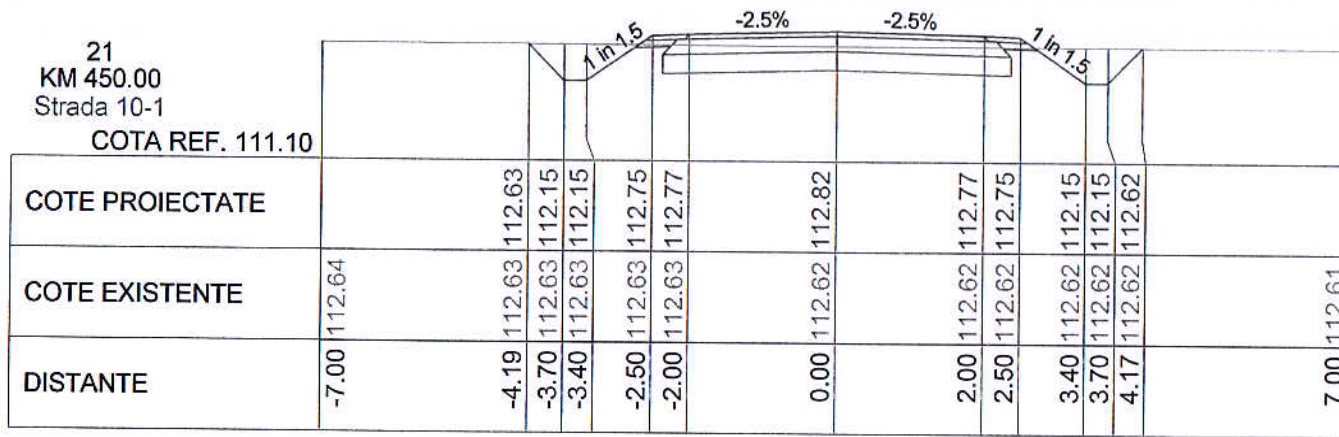

 S.C. "DROMCONS" S.R.L. SEBIS str. Codrului nr. 1 C.U.I 15624428 J02/9/12/2003 tel : +40(0)743 119 667, tel / fax: +40(0)357 437 554 e-mail : office@dromcons.ro		BENEFICIAR:	COMUNA VLADIMIRESCU	PROIECT NR.
		DENUMIRE PROIECT:	Amenajare străzi zonă locuințe, Vladimirescu zonă nouă, județul Arad	62/2013
SEF PROIECT:	dpl. ing. ADRIAN PRAHOVEANU	OBIECT:	DRUMURI	D.T.+C.S.
PROIECTAT	Dpl. Ing. FLORE CRISTIAN	SCARA:	1:1000 1:100	PROFILURI TRANSVERSALE CURENTE Strada 10
DESENAT:	Dpl. Ing. FLORE CRISTIAN	2013		

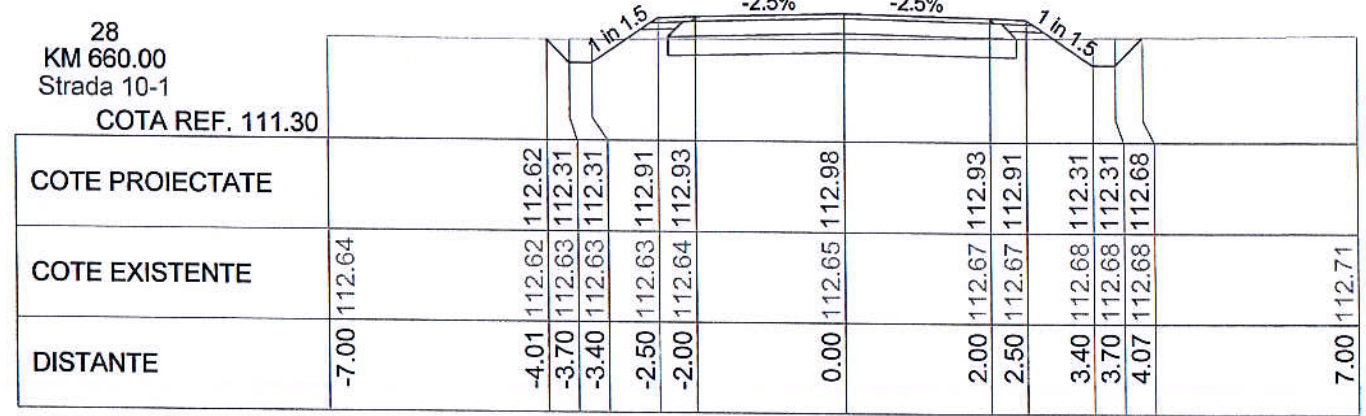
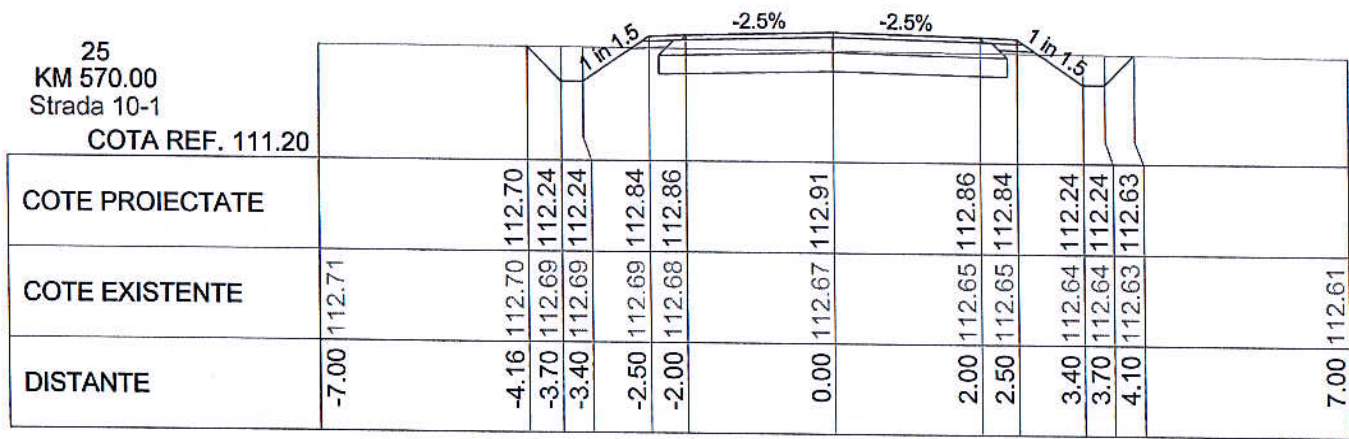
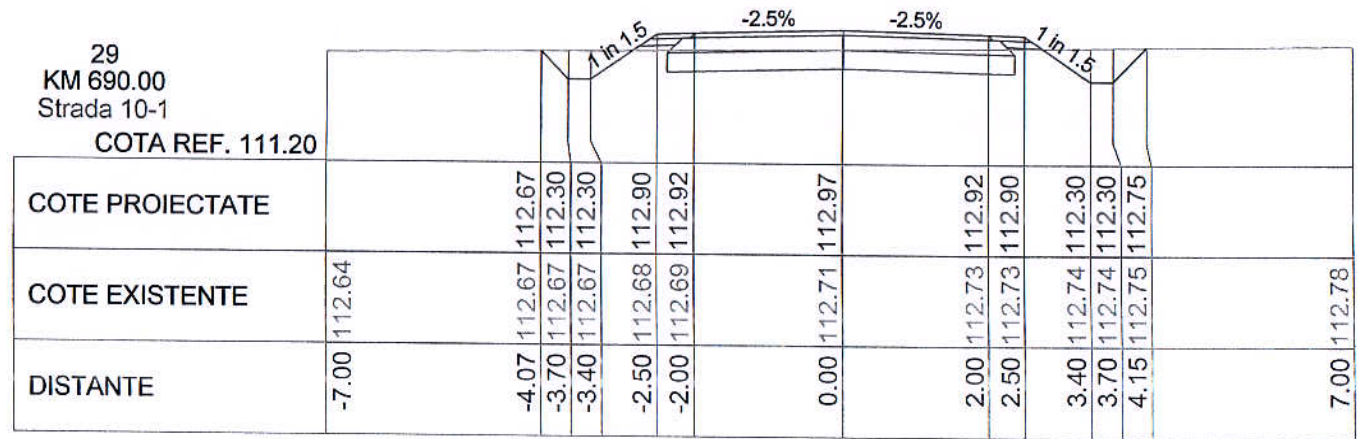
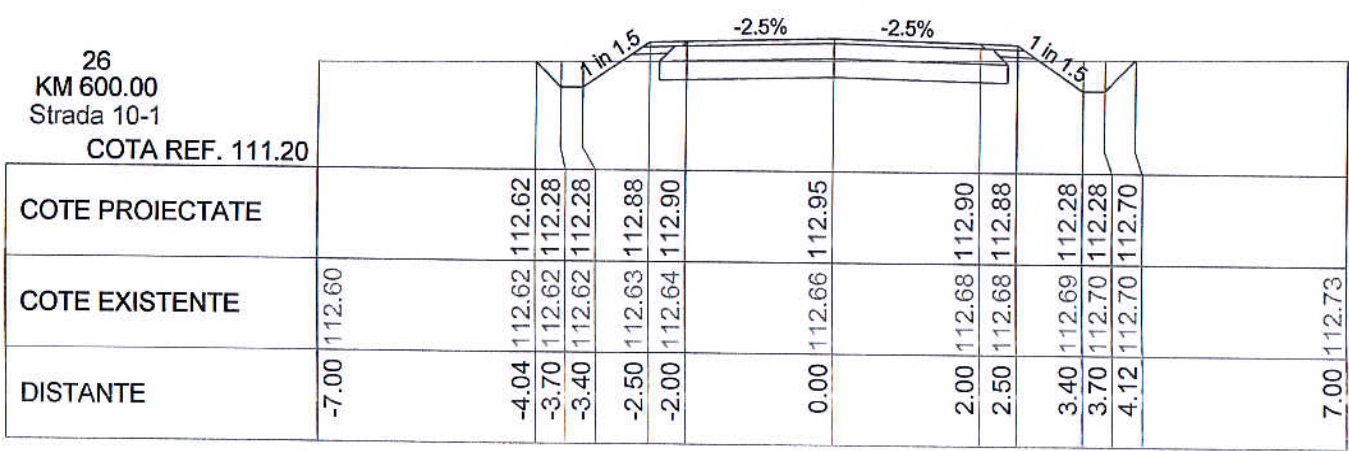
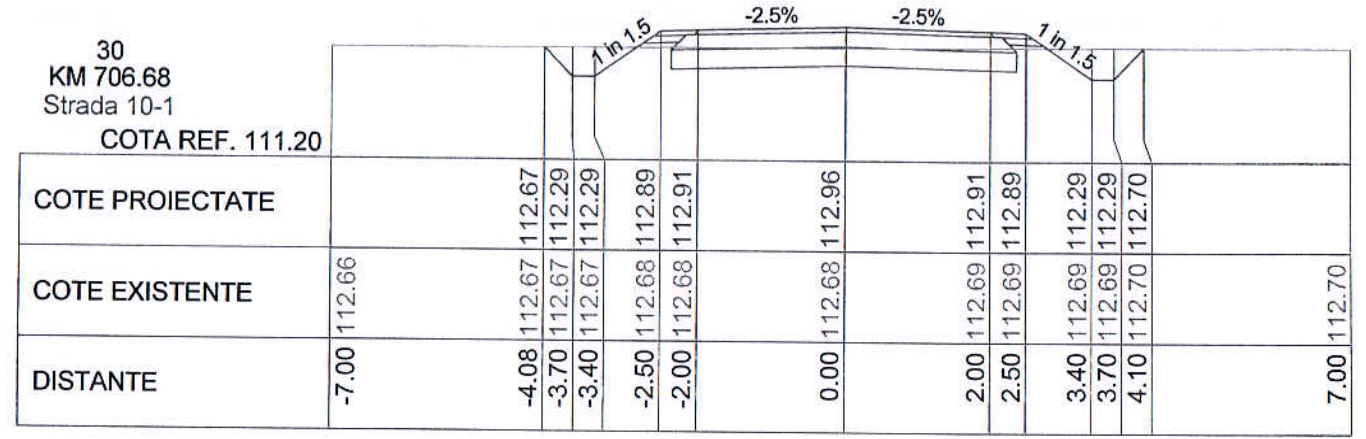
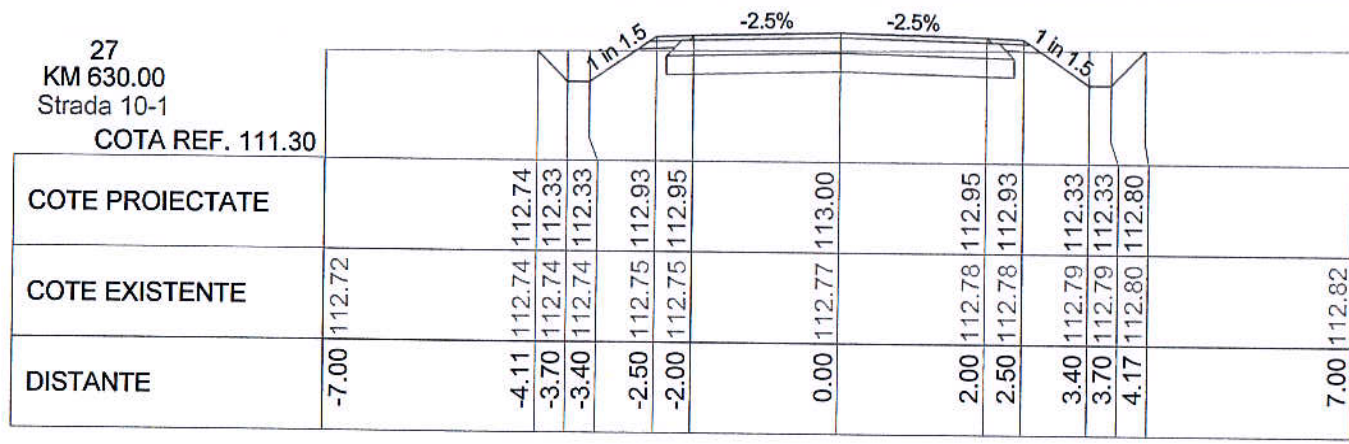

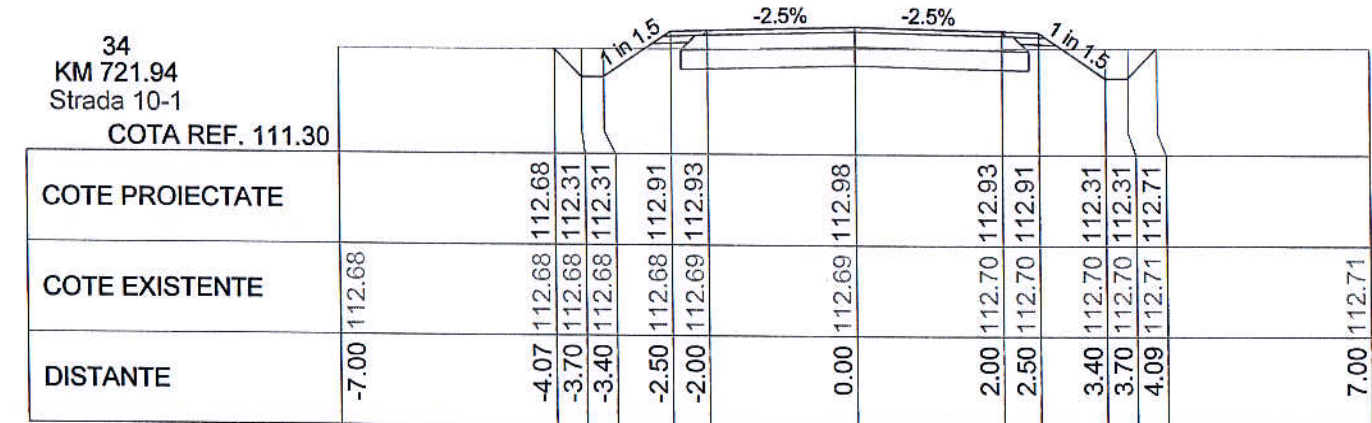
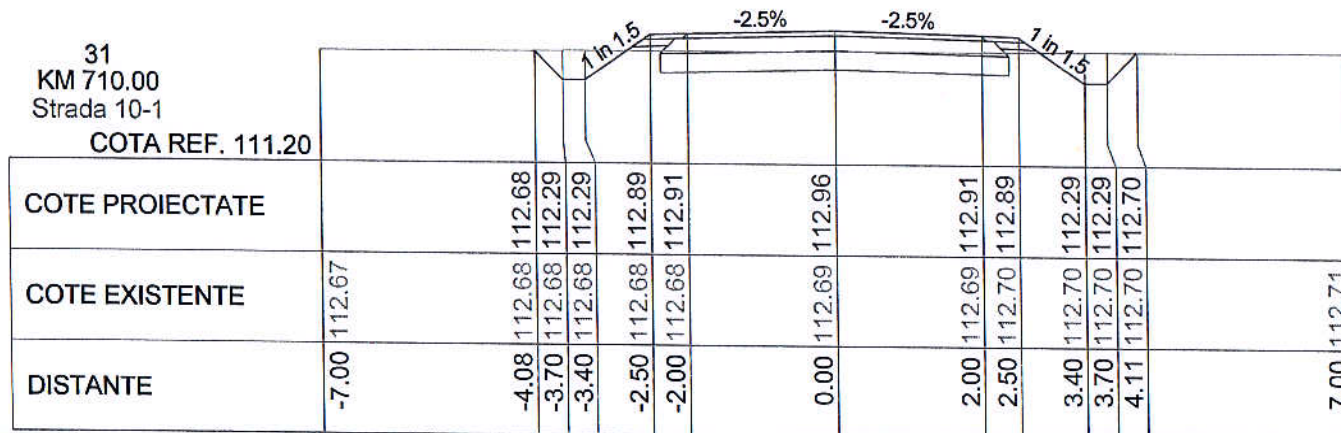
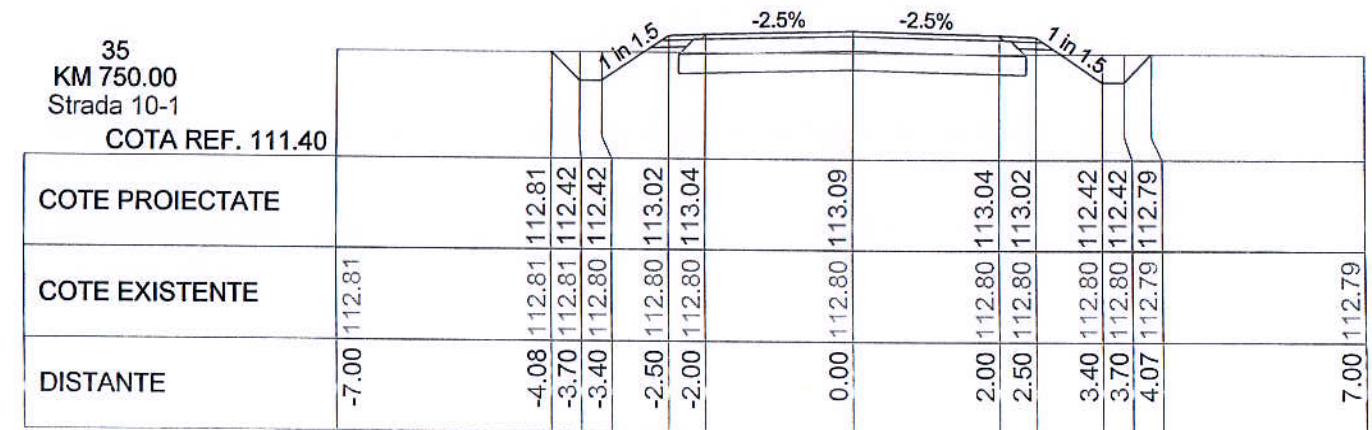
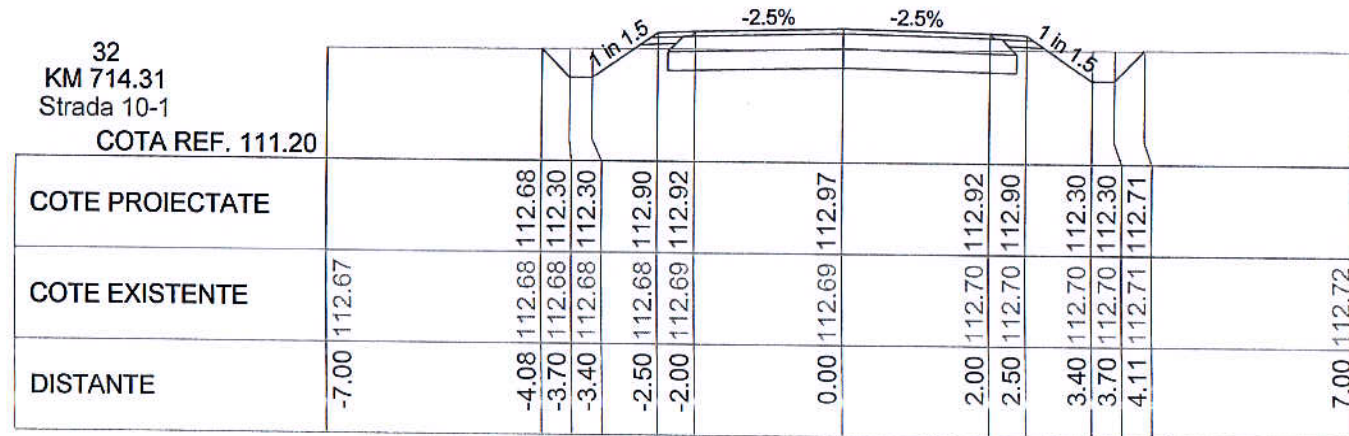
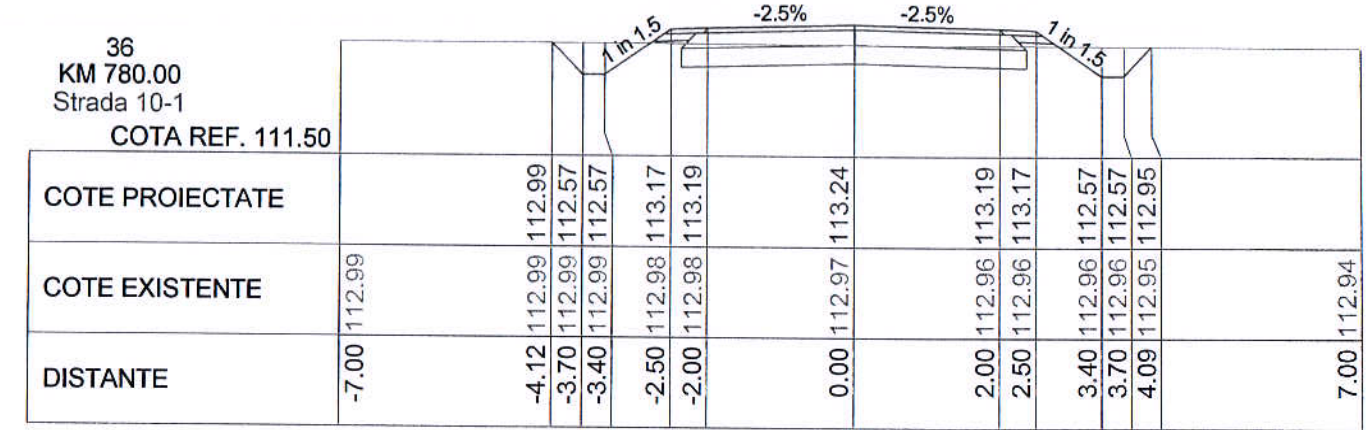
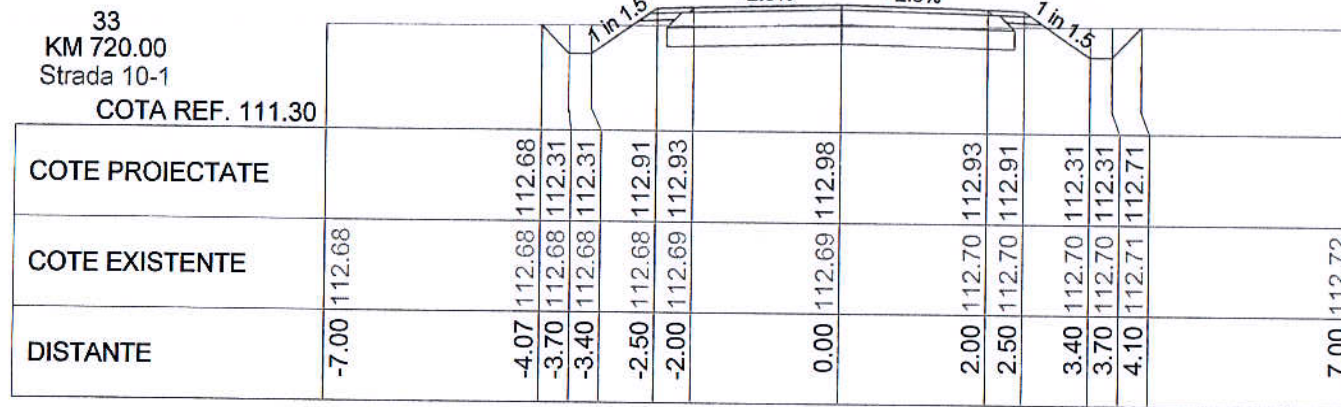

 S.C. "DROMCONS" S.R.L. SEBIS str. Codrului nr. 1 C.U.I 15624428 J02/9/12/2003 tel : +40(0)743 119 667, tel / fax: +40(0)357 437 554 e-mail : office@dromcons.ro	BENEFICIAR:	COMUNA VLADIMIRESCU	PROIECT NR.
	DENUMIRE PROIECT:	Amenajare străzi zonă locuințe, Vladimirescu zonă nouă, județul Arad	62/2013
SEF PROIECT:	dpl. ing. ADRIAN PRAHOVEANU	OBIECT:	DRUMURI
PROIECTAT	Dpl. Ing. FLORE CRISTIAN	SCARA:	1:1000 1:100
DESENAT:	Dpl. Ing. FLORE CRISTIAN		2013
		PROFILURI TRANSVERSALE CURENTE	Strada 10
			D.T.+C.S.
			PLANSĂ NR. 03D-32

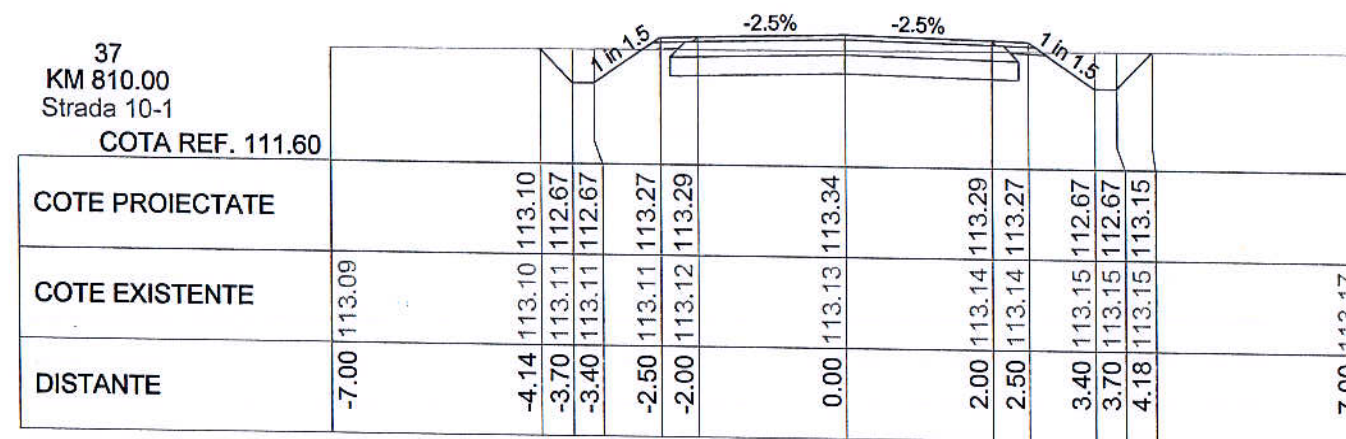
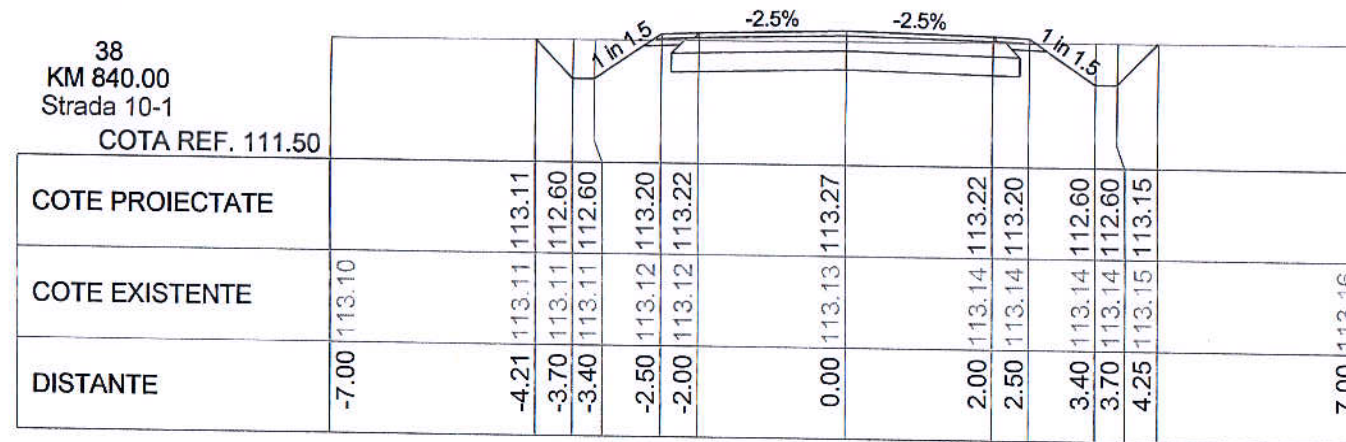
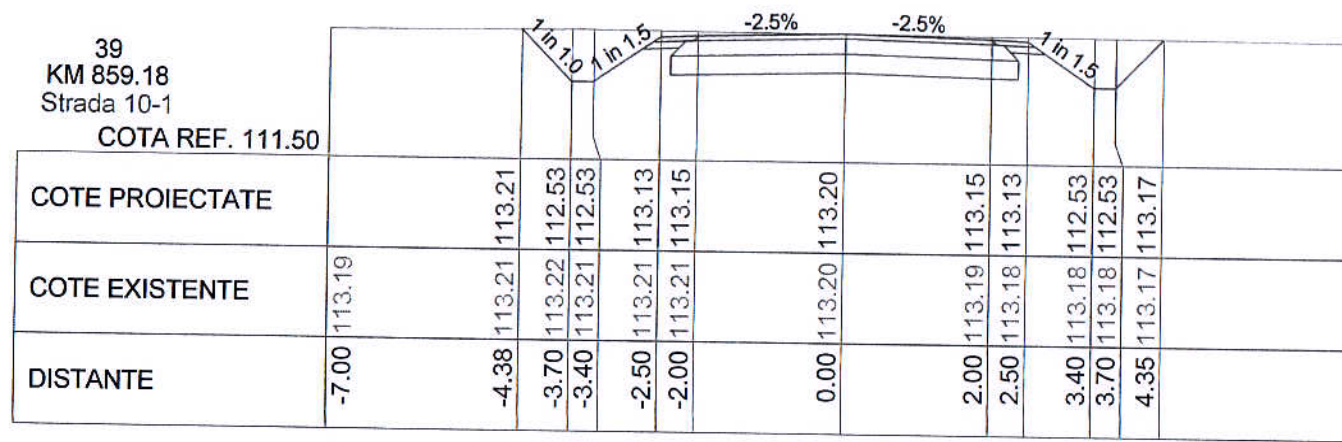

 S.C. "DROMCONS" S.R.L. SEBIS, str. Codrului nr. 1 C.U.I 15624428 J02/912/2003 tel : +40(0)743 119 667, tel / fax: +40(0)357 437 554 e-mail : office@dromcons.ro	BENEFICIAR:	COMUNA VLADIMIRESCU	PROIECT NR.
	DENUMIRE PROIECT:	Amenajare străzi zonă locuințe, Vladimirescu zonă nouă, județul Arad	62/2013
	OBIECT:	DRUMURI	D.T.+C.S.
SEF PROIECT:	dpl. ing. ADRIAN PRAHOVEANU	SCARA:	PROFILURI TRANSVERSALE CURENTE Strada 10
PROIECTAT	Dpl. ing. FLORE CRISTIAN	1:1000 1:100	
DESENAT:	Dpl. ing. FLORE CRISTIAN	2013	
			PLANSĂ NR. 03D-33



 S.C. "DROMCONS" S.R.L. SEBIS, str. Codrului nr. 1 C.U.I 15624428 J02/912/2003 tel : +40(0)743 119 667, tel / fax: +40(0)357 437 554 e-mail : office@dromcons.ro		BENEFICIAR:	COMUNA VLADIMIRESCU	PROIECT NR.	
	DENUMIRE PROIECT:	Amenajare străzi zonă locuințe, Vladimirescu zonă nouă, județul Arad	62/2013		
SEF PROIECT:	dpl. ing. ADRIAN PRAHOVEANU	OBIECT:	DRUMURI	D.T.+C.S.	
PROIECTAT	Dpl. Ing. FLORE CRISTIAN	SCARA:	1:1000 1:100	PROFILURI TRANSVERSALE CURENTE	
DESEANAT:	Dpl. Ing. FLORE CRISTIAN	2013		Strada 10	PLANSĂ NR. 03D-34

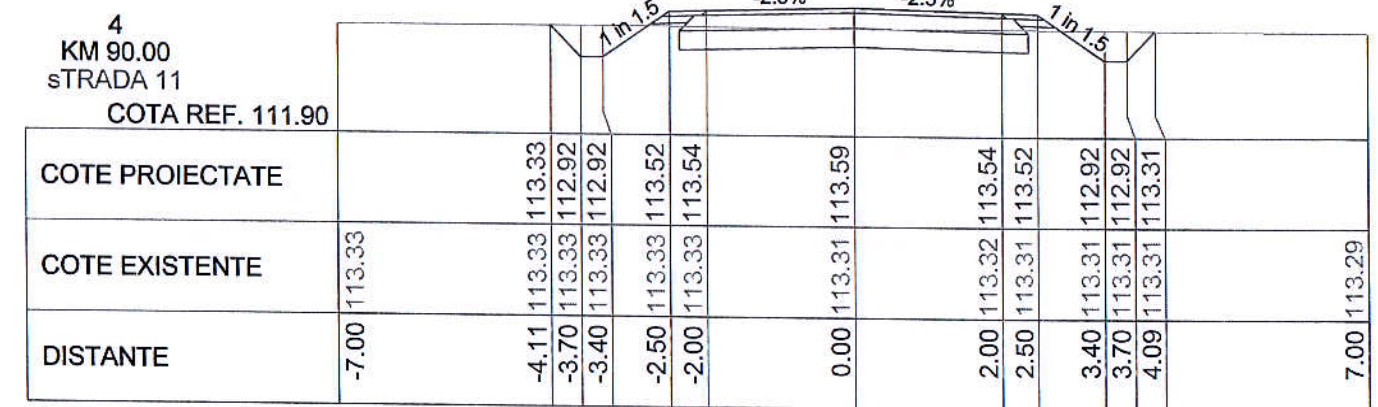
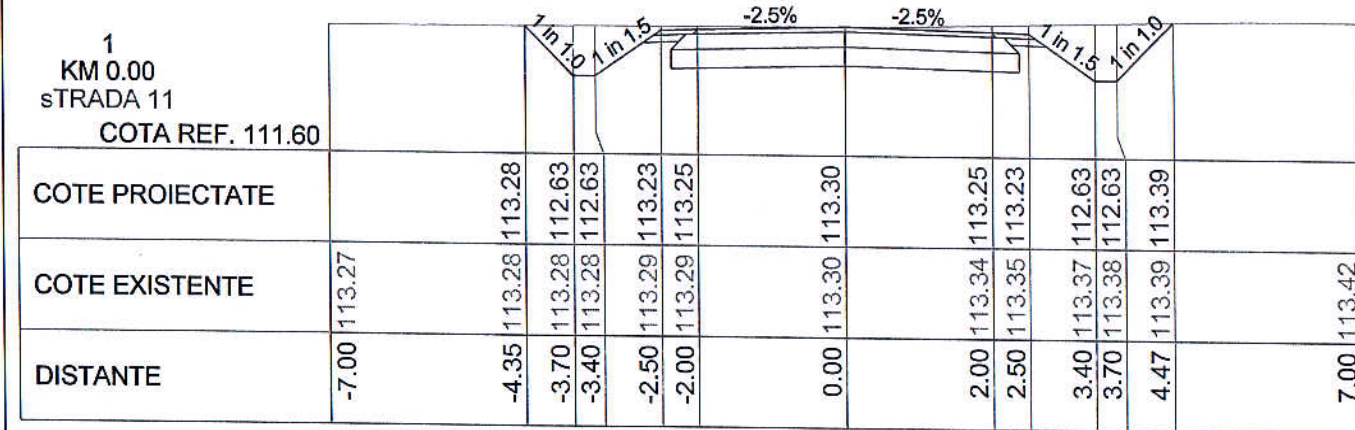
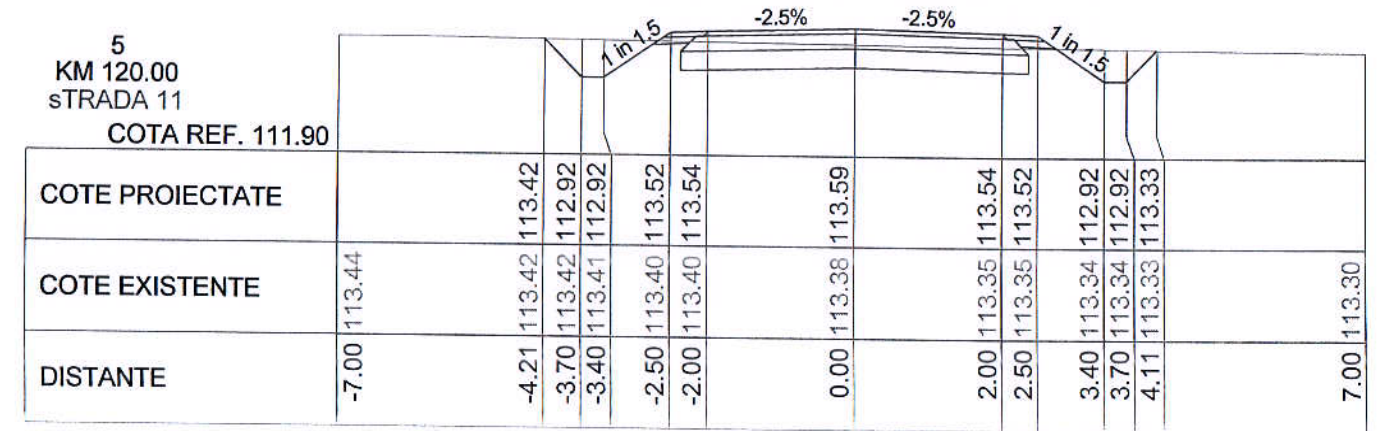
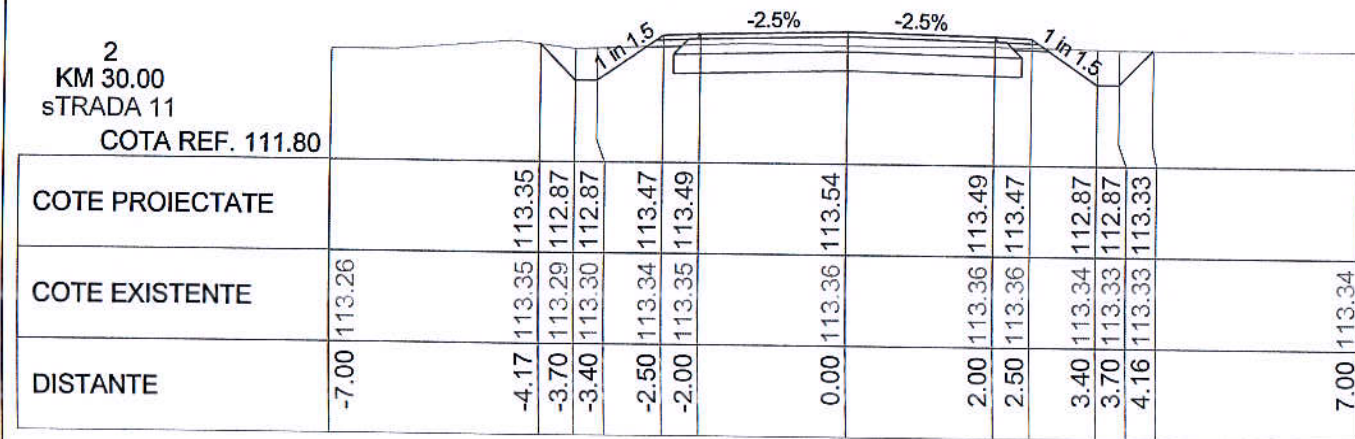
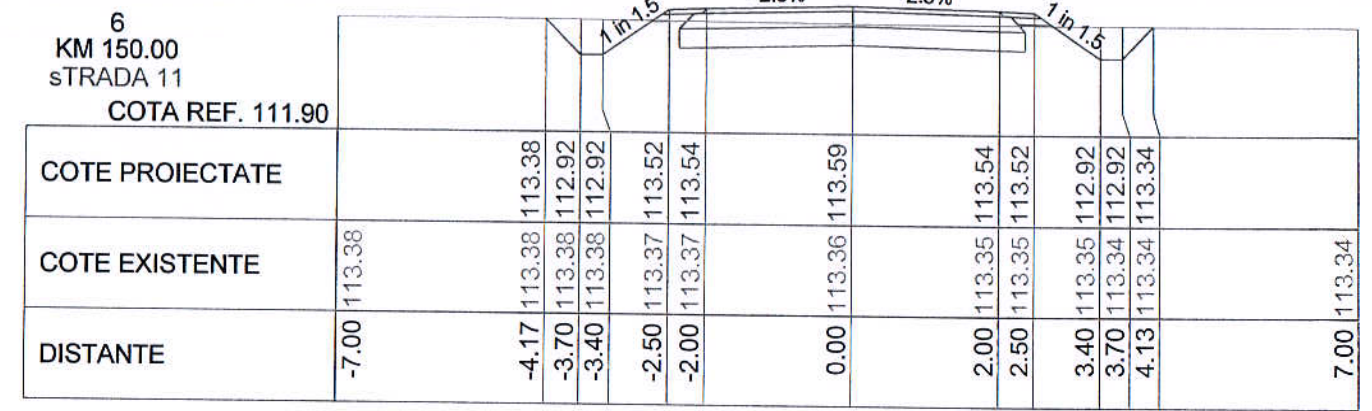
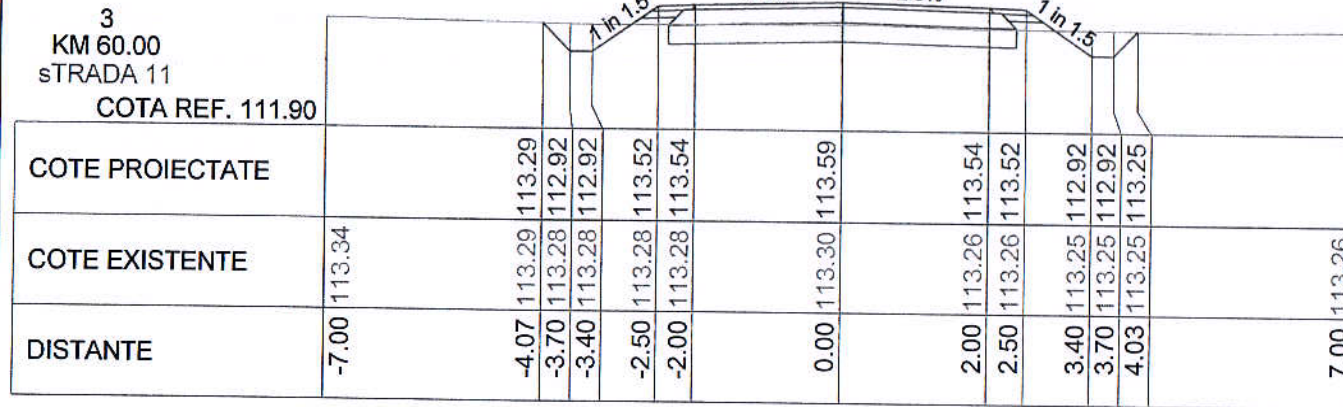

 S.C. "DROMCONS" S.R.L. SEBIS str. Codrul nr. 1 C.U.I 15624428 J02/912/2003 tel : +40(0)743 119 667, tel / fax: +40(0)357 437 554 e-mail : office@dromcons.ro	BENEFICIAR: COMUNA VLADIMIRESCU DENUMIRE PROIECT: Amenajare străzi zonă locuințe, Vladimirescu zonă nouă, județul Arad OBIECT: DRUMURI	PROIECT NR. 62/2013	
	SCARA: 1:1000 1:100 2013	PROFILURI TRANSVERSALE CURENTE Strada 11	D.T.+C.S.
	PLANSĂ NR. 03D-35		

8
KM 189.60
STRADA 11
COTA REF. 111.90

COTE PROIECTATE			113.40	113.40	112.91	112.91	113.51	113.53			113.58		113.53	113.51		112.91	112.91	113.38	
COTE EXISTENTE	113.40		113.40	113.40	112.91	112.91	113.39	113.39		113.39	113.58		113.39	113.51		112.91	112.91	113.38	113.38
DISTANTE	-7.00		-4.18	-3.70	-3.40	-2.50	-2.00		0.00			2.00	2.50		3.40	3.70	4.17		7.00

7
KM 180.00
STRADA 11
COTA REF. 111.90

COTE PROIECTATE			113.47	112.91	112.91	113.51	113.53			113.58		113.53	113.51		112.91	112.91	113.41		
COTE EXISTENTE	113.49		113.47	113.46	113.46	113.46	113.45		113.44	113.58		113.42	113.42		113.42	113.41	113.41		113.39
DISTANTE	-7.00		-4.25	-3.70	-3.40	-2.50	-2.00		0.00			2.00	2.50		3.40	3.70	4.20		7.00



 SEBIS, str. Codrului nr. 1 C.U.I 15624428 J02/912/2003 tel : +40(0)743 119 667. tel / fax: +40(0)357 437 554 e-mail : office@dromcons.ro	S.C. "DROMCONS" S.R.L		BENEFICIAR:	COMUNA VLADIMIRESCU	PROIECT NR.
		DENUMIRE PROIECT:	Amenajare străzi zonă locuințe, Vladimirescu zonă nouă, Județul Arad		62/2013
SEF PROIECT:	dpl. Ing. ADRIAN PRAHOVEANU	SCARA:			D.T.+C.S.
PROIECTAT	Dpl. Ing. FLORE CRISTIAN	1:1000 1:100	PROFILURI TRANSVERSALE CURENTE Strada 11		PLANSĂ NR. 03D-36
DESESTAT:	Dpl. Ing. FLORE CRISTIAN	2013			

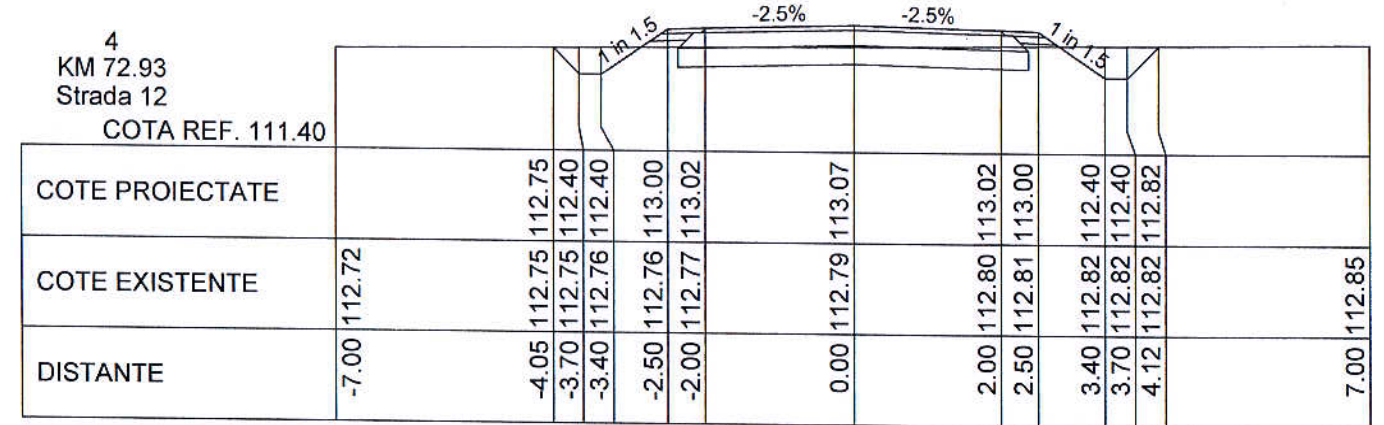
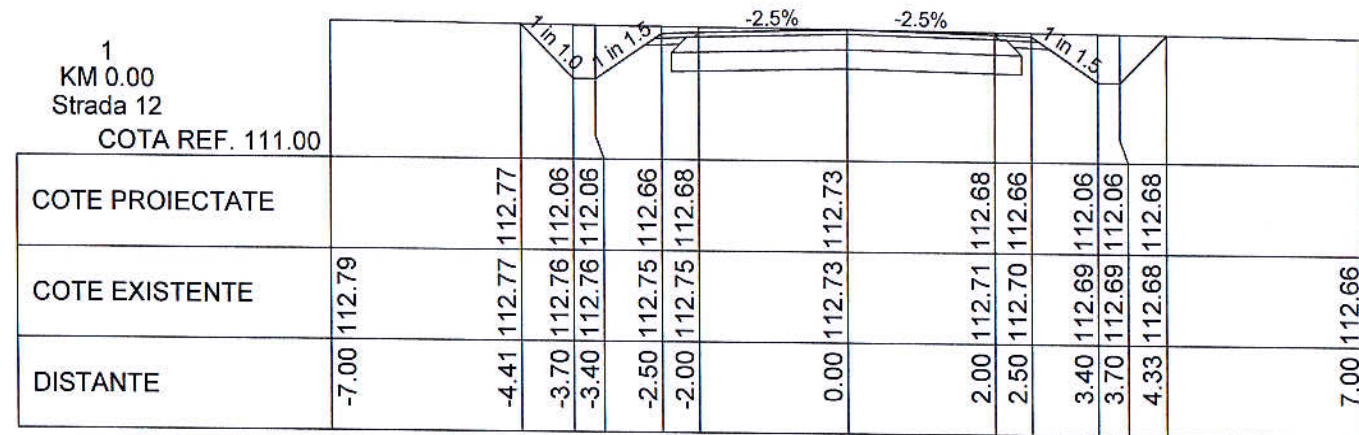
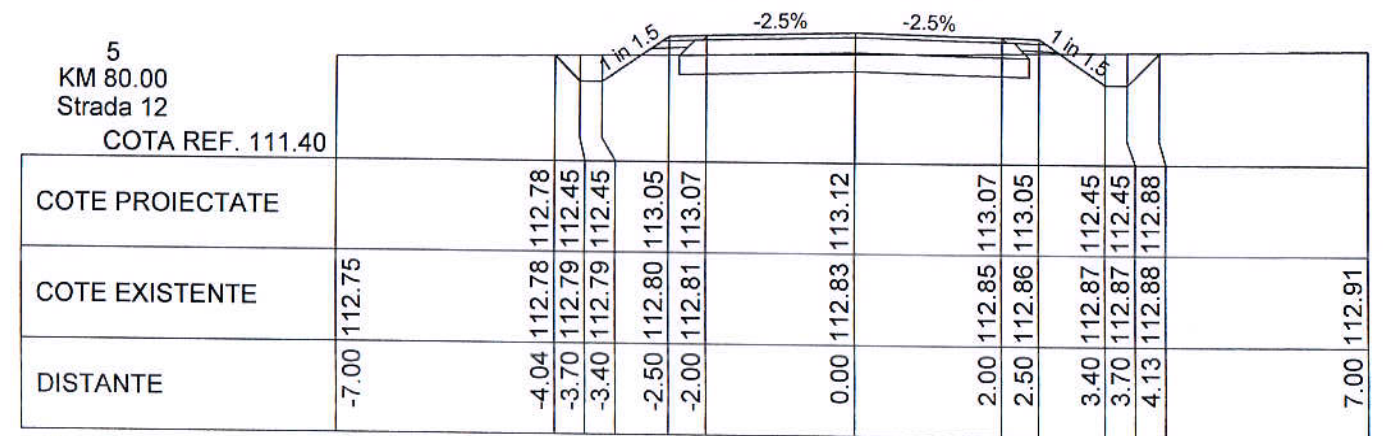
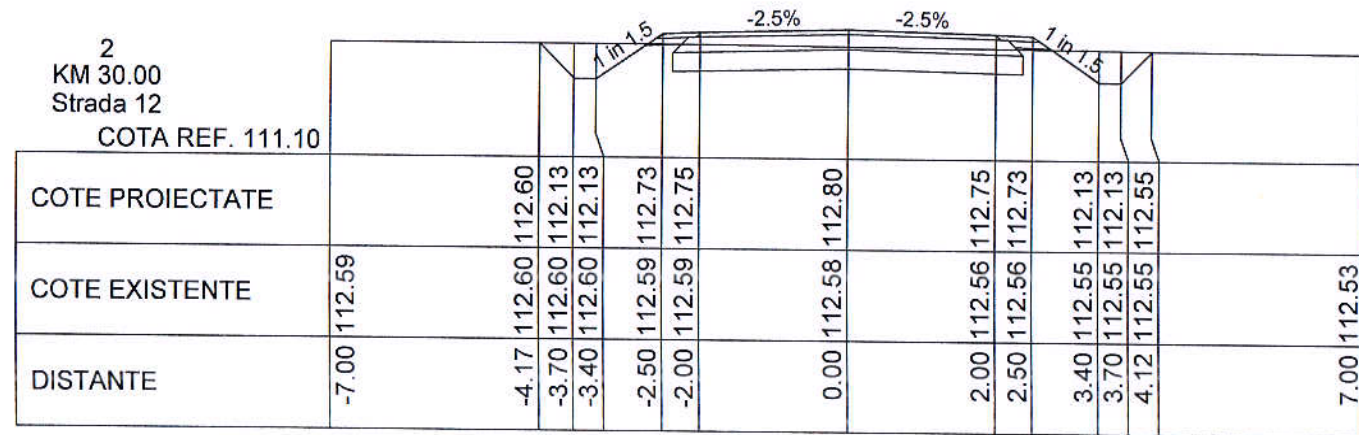
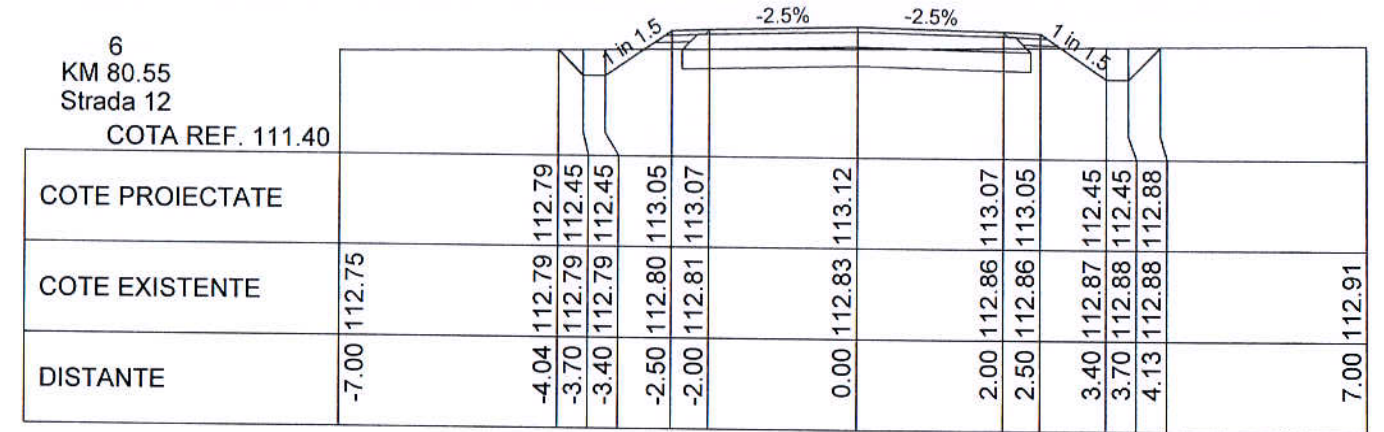
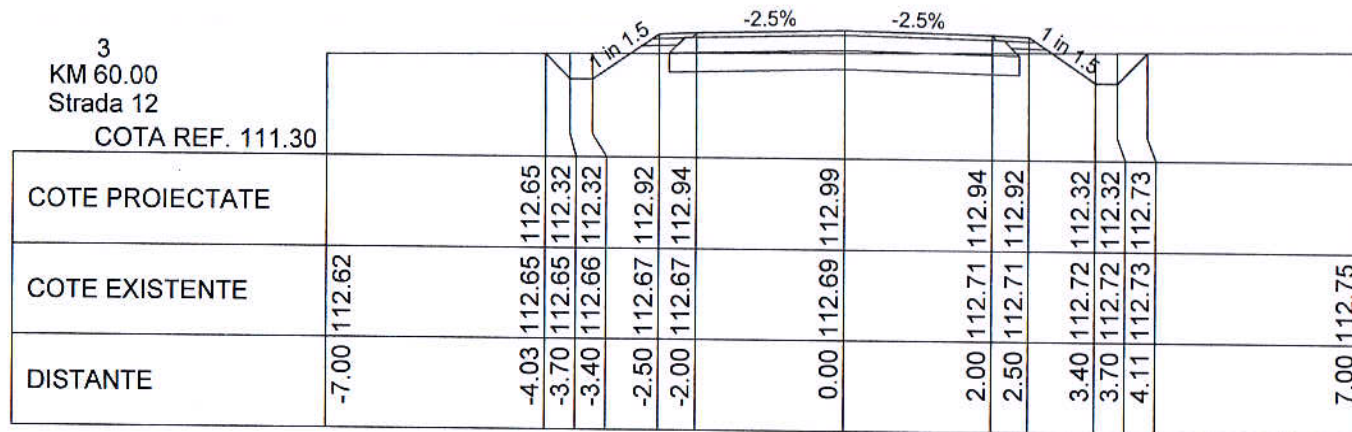

 S.C. "DROMCONS" S.R.L. SEBIS, str. Codrului nr. 1 C.U.I 15624428 J02/912/2003 tel: +40(0)743 119 667, tel / fax: +40(0)357 437 554 e-mail: office@dromcons.ro	BENEFICIAR:	COMUNA VLADIMIRESCU	PROIECT NR.
	DENUMIRE PROIECT:	Amenajare străzi zonă locuințe, Vladimirescu zonă nouă, județul Arad	62/2013
	OBIECT:	DRUMURI	
SEF PROIECT:	dpl. ing. ADRIAN PRAHOVEANU	SCARA:	D.T.+C.S.
PROIECTAT	Dpl. Ing. FLORE CRISTIAN	1:1000 1:100	PROFILURI TRANSVERSALE CURENTE Strada 12
DESENAT:	Dpl. Ing. FLORE CRISTIAN	2013	

9
KM 120.00
Strada 12
COTA REF. 111.50

COTE PROIECTATE												
COTE EXISTENTE	-7.00	112.78								7.00	112.93	
DISTANTE			-3.98	112.81	112.81	112.81		0.00	112.85	113.21		
				-3.70	112.82	112.54						
				-3.40	112.82	112.54						
				-2.50	112.83	113.14						
				-2.00	112.83	113.16						
								2.00	112.87	113.16		
								2.50	112.88	113.14		
								3.40	112.89	112.54		
								3.70	112.89	112.54		
								4.06	112.90	112.90		

8
KM 90.00
Strada 12
COTA REF. 111.50

COTE PROIECTATE												
COTE EXISTENTE	-7.00	112.84									7.00	113.01
DISTANTE			-4.07	112.88	112.88			0.00	112.93	113.18		
				-3.70	112.88	112.51						
				-3.40	112.89	112.51						
				-2.50	112.90	113.11						
				-2.00	112.90	113.13						
								2.00	112.95	113.13		
								2.50	112.96	113.11		
								3.40	112.97	112.51		
								3.70	112.97	112.51		
								4.17	112.98	112.98		

7
KM 88.16
Strada 12
COTA REF. 111.40

COTE PROIECTATE												
COTE EXISTENTE	-7.00	112.80									7.00	112.97
DISTANTE			-4.04	112.84	112.84			0.00	112.89	113.17		
				-3.70	112.84	112.50						
				-3.40	112.85	112.50						
				-2.50	112.86	113.10						
				-2.00	112.86	113.12						
								2.00	112.91	113.12		
								2.50	112.92	113.10		
								3.40	112.93	112.50		
								3.70	112.93	112.50		
								4.14	112.94	112.94		

12
KM 188.32
Strada 12
COTA REF. 111.50

COTE PROIECTATE												
COTE EXISTENTE	-7.00	113.21									7.00	113.30
DISTANTE			-4.33	113.23	113.23			0.00	113.27	113.27		
				-3.70	113.24	112.60						
				-3.40	113.24	112.60						
				-2.50	113.25	113.20						
				-2.00	113.25	113.22						
								2.00	113.29	113.22		
								2.50	113.29	113.20		
								3.40	113.30	112.60		
								3.70	113.30	112.60		
								4.40	113.30	113.30		

11
KM 180.00
Strada 12
COTA REF. 111.50

COTE PROIECTATE												
COTE EXISTENTE	-7.00	112.98									7.00	113.19
DISTANTE			-4.11	113.00	113.00			0.00	113.07	113.26		
				-3.70	113.00	112.59						
				-3.40	113.01	112.59						
				-2.50	113.02	113.19						
				-2.00	113.03	113.21						
								2.00	113.11	113.21		
								2.50	113.12	113.19		
								3.40	113.13	112.59		
								3.70	113.14	112.59		
								4.26	113.15	113.15		

10
KM 150.00
Strada 12
COTA REF. 111.50

COTE PROIECTATE												
COTE EXISTENTE	-7.00	112.77									7.00	112.90
DISTANTE			-3.93	112.80	112.80			0.00	112.83	113.23		
				-3.70	112.80	112.56						
				-3.40	112.80	112.56						
				-2.50	112.81	113.16						
				-2.00	112.81	113.18						
								2.00	112.85	113.18		
								2.50	112.86	113.16		
								3.40	112.87	112.56		
								3.70	112.87	112.56		
								4.01	112.87	112.87		



 S.C. "DROMCONS" S.R.L. SEBIS, str. Codrului nr. 1 C.U.I 15624428 J02/912/2003 tel : +40(0)743 119 667, tel / fax: +40(0)357 437 554 e-mail : office@dromcons.ro	BENEFICIAR: COMUNA VLADIMIRESCU DENUMIRE PROIECT: Amenajare străzi zonă locuințe, Vladimirescu zonă nouă, județul Arad OBIECT: DRUMURI SCARA: 1:1000 1:100 2013	PROIECT NR. 62/2013 D.T.+C.S. PLANSA NR. 03D-38
	SEF PROIECT: dpl. ing. ADRIAN PRAHOVEANU PROIECTAT Dpl. Ing. FLORE CRISTIAN DESENAT: Dpl. Ing. FLORE CRISTIAN	PROFILURI TRANSVERSALE CURENTE Strada 12

DETALIU PODET Ø300
Sectiunea A-A
sc 1:50

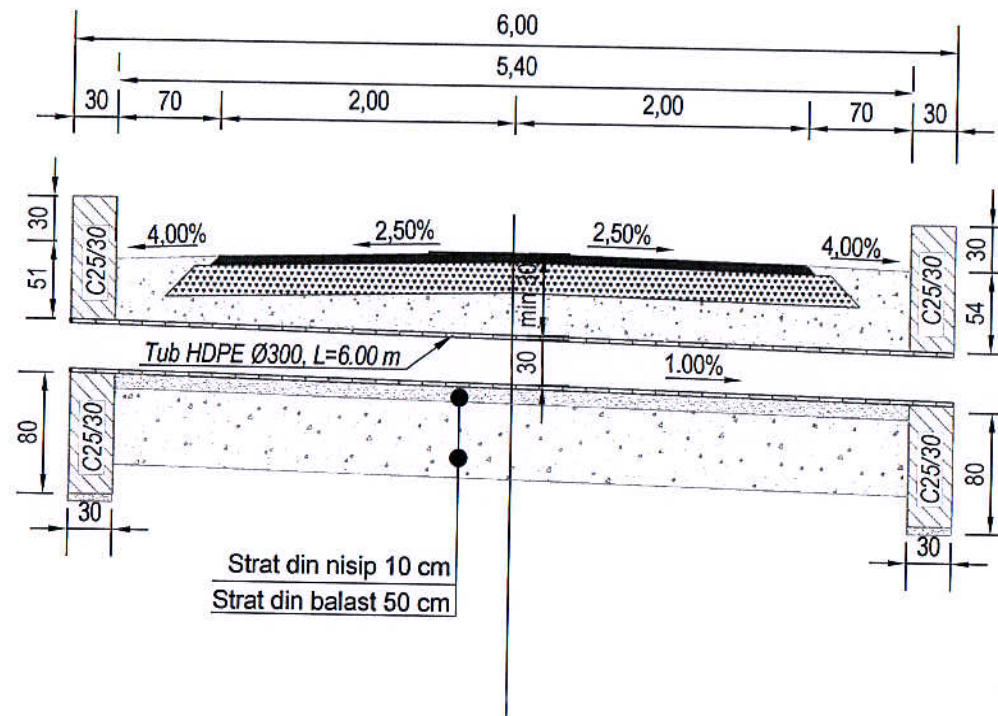

Vedere in plan
sc 1:50

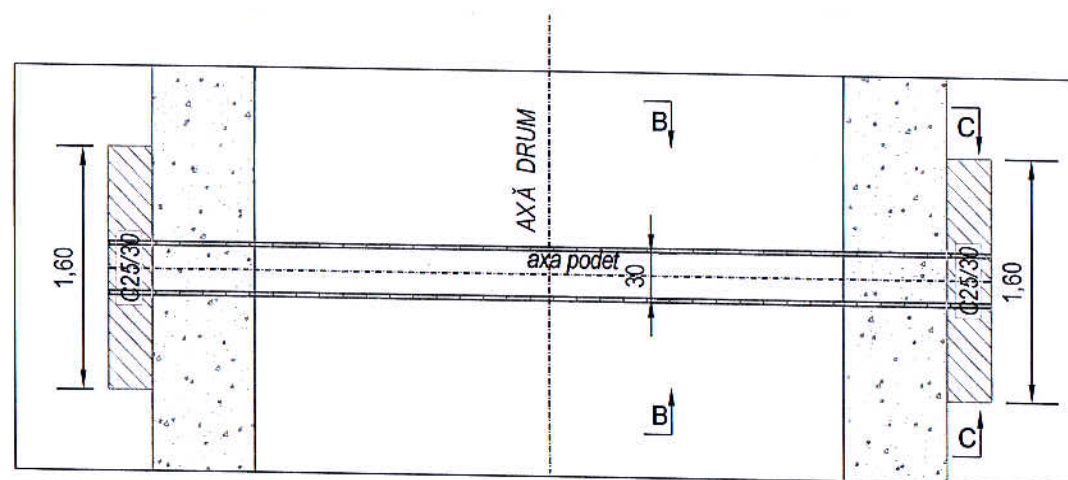

Sectiunea B-B
sc 1:50

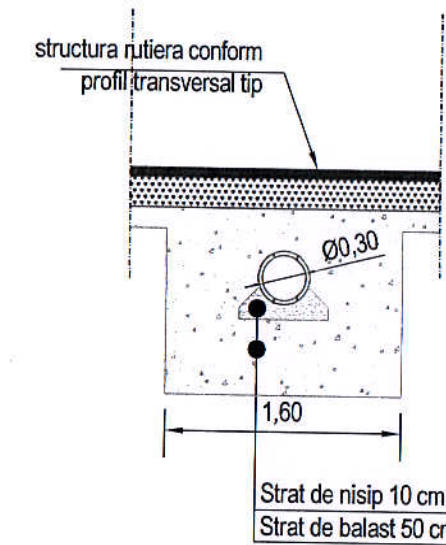

Sectiunea C-C
sc 1:50

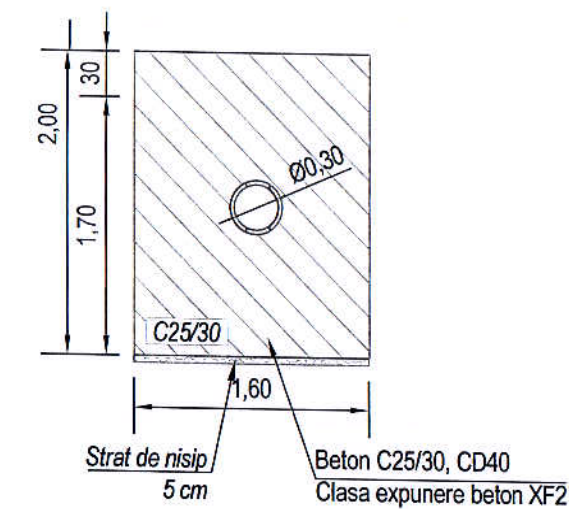

 S.C. "DROMCONS" S.R.L. SEBIS, str. Codrul nr. 1 C.U.I. 15624428 J02/912/2003 tel : +40(0)743 119 667, tel / fax: +40(0)357 437 554 e-mail : office@dromcons.ro	BENEFICIAR:	COMUNA VLADIMIRESCU	PROIECT NR.
	DENUMIRE PROIECT:	Amenajare străzi zonă locuințe, Vladimirescu zonă nouă, județul Arad	62/2013
SEF PROIECT:	dpl. ing. ADRIAN PRAHOVEANU	OBIECT:	DRUMURI
PROIECTAT	Dpl. Ing. FLORE CRISTIAN	SCARA:	1:50
DESENAT:	Dpl. Ing. FLORE CRISTIAN		2013
DETALIU PODET Ø300			D.T.+C.S.
			PLANSĂ NR. 06D-01